



Made in USA

Programmable Thermostat

BTM Thermostat

with *Humidity Control*

Auto Changeover
Dual Power

- 7-Day, 5-2-Day, or 5-1-1- Day Programmable
- Configurable for Multiple Systems
- Large Display with Backlight
- Selectable Fahrenheit or Celsius
- Icon Indicator Lights
- Relay Outputs – Minimum Voltage Drop in Thermostat
- Remote Sensor Compatible
- Ideally Suited for:
 - Residential (New Construction/Replacement)
 - Light Commercial
- Works with two-transformer systems

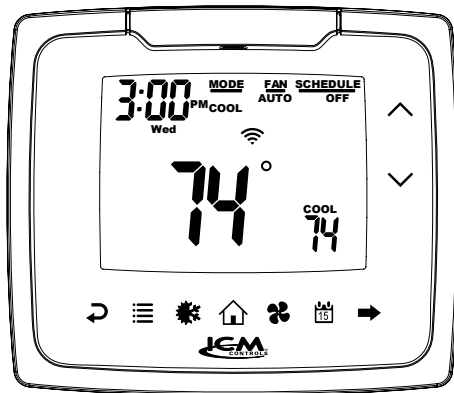

Installation, Operation & Application Guide

For more information on our complete range of American-made products, wiring diagrams, troubleshooting tips, and more, please visit us at www.icmcontrols.com

ICMTM
CONTROLS

Thermostat Controls

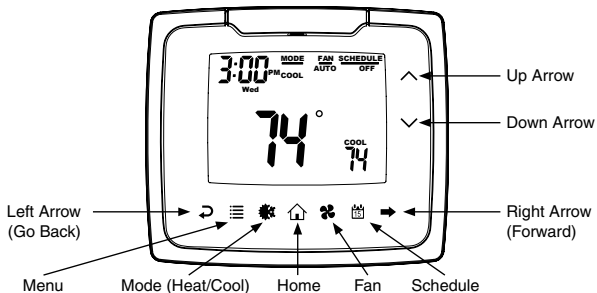

Package Contents/Tools Required

Package includes: Thermostat, base, wiring labels, screws and wall anchors, 2 “AA” Alkaline batteries and Installation, Operation and Application Guide

Tools required for installation: Drill with 3/16” bit, hammer, screwdriver

Specifications

Electrical Rating: 24 VAC (18-30 VAC), 1 amp maximum per output terminal, 5 amp maximum total load

DC Power: 3.0 VDC (2 “AA” Alkaline batteries)

Temperature Control Range: 45°F to 90°F (7°C to 32°C) Accuracy: $\pm 1^\circ\text{F}$ ($\pm 0.5^\circ\text{C}$)

Anti-short Cycle: 4 minutes (bypass anti-short cycle delay by returning to OFF mode and pressing the  icon).

Backlight Operations: 15 seconds

Humidity Control: 10% to 80%

System Configurations: All may be used with heat pump, gas, oil, electric, and air conditioning

- I1010HR: 1-stage heat, 1-stage cool
- I2010HR: 2-stage heat, 1-stage cool
- I2020HR: 2-stage heat, 2-stage cool

Important Safety Information

WARNING! Always turn off power at the main power supply before installing, cleaning, or removing thermostat.

- This thermostat is for 24 VAC applications only; do not use on voltages over 30 VAC.
- Do not short across terminals of gas valve or system control to test operation; this will damage your thermostat and void your warranty.
- All wiring must conform to local and national electrical and building codes.
- Do not use air conditioning when the outdoor temperature is below 50 degrees; this can damage your A/C system and cause personal injuries.
- Use this thermostat only as described in this manual.

To Remove Existing Thermostat



ELECTRICAL SHOCK HAZARD – Turn off power at the main service panel by removing the fuse or switching the appropriate circuit breaker to OFF position before removing the existing thermostat.

1. Turn off power to heating & cooling system by removing the fuse or switching the appropriate circuit breaker off.
2. Remove cover of old thermostat; this should expose the wires.
3. Label the existing wires with the enclosed wire labels before removing wires.
4. After labeling wires, remove wires from wire terminals.
5. Remove existing thermostat base from wall.
6. Refer to the following section for instructions on how to install this thermostat.

Battery Installation and Information

Two “AA” alkaline batteries are used to power the thermostat. They are installed into the back of the thermostat. Orient them in the correct direction as shown on the plastic thermostat case.

The batteries should be changed yearly to prevent leakage from damaging the thermostat and voiding your warranty.

If the batteries are not changed the thermostat will eventually display E_r and conserve energy by maintaining a lower setpoint in heating and a higher setpoint in cooling.

To Install Thermostat



ELECTRICAL SHOCK HAZARD – Turn off power at the main service panel by removing the fuse or switching the appropriate circuit breaker to OFF position before removing the existing thermostat.

IMPORTANT: Thermostat installation must conform to local and national building and electrical codes and ordinances.

**** Note:** Mount the thermostat about five feet above the floor. Do not mount the thermostat on an outside wall, in direct sunlight, behind a door, or in an area affected by a vent or duct.

1. Turn off power to heating & cooling system by removing the fuse or switching the appropriate circuit breaker off.
2. Put thermostat sub base against the wall where you plan to mount it (be sure wires will feed through the wire opening in the sub base of the thermostat).
3. Mark the placement of the mounting holes.
4. Set thermostat sub base and thermostat away from working area.
5. Using a 3/16" drill bit, drill holes in the places you have marked for mounting.
6. Use a hammer to tap supplied anchors in mounting holes.
7. Use supplied screws to mount thermostat sub base to wall (make sure thermostat wire is through hole).
8. Insert stripped, labeled wires in matching wire terminals. Tighten screws to secure wires.

CAUTION! Be sure exposed portion of wires does not touch other wires.

9. Gently tug wire to be sure of proper connection. Double check that each wire is connected to the proper terminal.
10. Install 2 "AA" batteries into back of thermostat.
11. Snap thermostat onto the sub base.
12. Turn on power to the system at the main service panel.
13. Configure thermostat to match the type of system you have.
14. Test thermostat operation as described in "Testing the Thermostat".

Terminal Designator Descriptions

SC, S1, S2 – Remote sensor or outdoor sensor

RC, RH – 24 VAC hot

C – 24 VAC common

Y1 – 1st stage cool, 1st stage heat for heat pumps

Y2 – Second stage cool for 2-compressor systems. Second stage heat for 2-compressor heat pump systems.

G – Fan

W1/O/B – Configurable

W1 – 1st stage heat for non-heat pump systems

O – Cool active reversing valve

B – Heat active reversing valve

W2 – 2nd stage heat for 1 compressor heat pump and non-heat pump

AUX – Humidifier or dehumidifier

**** Note:** *Not all terminals are used in every model.*

Wiring Diagrams

1010HR Heating/Cooling

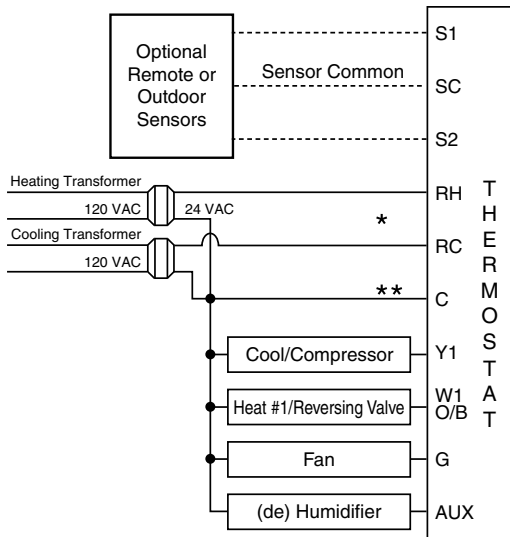

2010HR Heating/Cooling

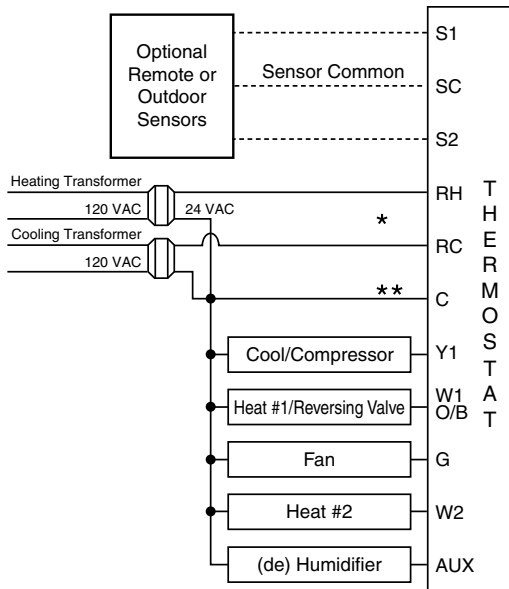

* Remove factory-installed jumper for systems with two transformers.

** Common wire is optional with batteries installed.

** **Note:** *Not all terminals may be used with every model.*

Wiring Diagrams (continued)

⌚ 2020HR Heating/Cooling

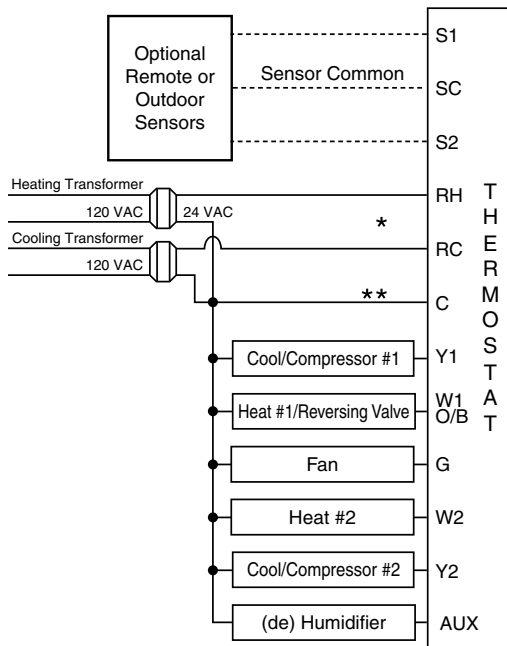

* Remove factory-installed jumper for systems with two transformers.

** Common wire is optional with batteries installed.

** **Note:** *Not all terminals may be used with every model.*

Remote Sensor Installation (Optional)

Terminals S1, S2, and SC are used with remote sensors. S1 can be used with a remote sensor to monitor indoor or outdoor temperatures. An outdoor remote sensor can be used to change system operation based on the outdoor temperature with heat pumps with gas/oil backup or heat pumps with electric backup. An indoor remote sensor is used to read the indoor temperature in a different location. This is beneficial when the thermostat is not mounted in the ideal location.

S2 is a 10kΩ NTC thermistor sensor that can only monitor the temperature in a different area.

1. Remove cover from remote sensor housing.
2. Select an appropriate location for mounting the remote sensors.
3. Mount the remote sensors using hardware provided.
4. Install two-strand shielded wire between the S1 terminal on the remote sensor and the S1 terminal on the thermostat.
5. Install two-strand shielded wire between the 10kΩ NTC remote sensor and the S2 terminal on the thermostat.
6. From both remote sensors, install a two-strand shielded wire from their common to the SC terminal on the thermostat.
7. Configure the thermostat to work with the remote sensor.

Ordering Information:

Remote Sensor 1

- Indoor remote sensor: **ACC-RT104**
- Outdoor remote sensor: **ACC-OD104**

Remote Sensor 2

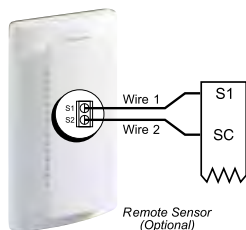

- 10kΩ NTC thermistor sensor



** Note:

Remote or outdoor sensor reading can be displayed by

pressing the  icon.

Press , select **MENU VIEW**
press 

1010HR Output Chart

	1 ST Cool	1 ST Heat
Heat/Cool	Y1, G	W1, G*
Heat Pump (One Compressor)	Y1, G, O	Y, G, B

* G not on for gas/oil systems

2010HR Output Chart

	1 ST Cool	1 ST Heat	2 ND Heat
Heat/Cool	Y1, G	W1, G*	W1, W2, G*
Heat Pump (One Compressor)	Y1, G, O	Y1, G, B	Y1, G, B, W2
Emergency Heat (Heat Pump Only)	N/A	W2, G	N/A

* G not on for gas/oil systems

2020HR Output Chart

	1 ST Cool	2 ND Cool	1 ST Heat	2 ND Heat
Heat/Cool	Y1, G	Y1, Y2, G	W1, G*	W1, W2, G*
Heat Pump (One Compressor)	Y1, G, O	Y1, G, O	Y1, G, B	Y1, W2, G, B
Heat Pump (Two Compressors)	Y1, G, O	Y1, Y2, G, O	Y1, G, B	Y1, Y2, G, B
Emergency Heat (Heat Pump Only)	N/A	N/A	W2, G	N/A

* G not on for gas/oil systems

Humidity Output Chart

	(De)humidification Setting	With Humidity Control Demand
Humidification Only	No	N/A
	Heat	W
	Heat-Fan	W and/or G
Dehumidification Only	Cool-No	G only
	Cool-Fan	Y and/or G

Note:

When in dehumidification mode and EAC is set to Cool-2, Y2 will energize to extend cooling cycle. See Configuration menu section 21, Page 17.

Configuration and Thermostat Lock

During Configuration Mode, certain settings are protected by a numeric code access screen to prevent unintentional changes that could potentially damage the system or create a dangerous condition.

Whenever changes are attempted to one of the critical settings, the unlock code screen will appear:



The unlock code for these critical settings can be found during the power-up sequence.

The large number (indicated by "98" in the diagram) is the code that will unlock the desired configuration setting.

The smaller numbers (indicated by "93" and "82" in the diagram) are codes used to lock and unlock your thermostat to prevent tampering.

To view the default codes for your thermostat, remove the thermostat from the sub base and, if using batteries, remove one battery for 10 seconds. Replacing the batteries or reinstalling thermostat will cause the codes to display for approximately 5 seconds.

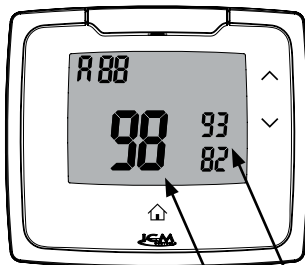

Write your codes here

Thermostat lock code

Configuration safety lock code

Locking & Unlocking Thermostat

To lock and unlock thermostat, perform the following steps:

Press , then , then **MENU LOCK**, then 

Use  &  to select digit.



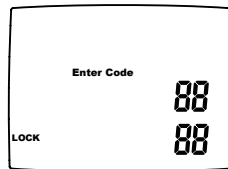

Use  &  to set number.

Press  to lock or unlock.



Changing the Lock Code

To change the lock code, do the following:

1. Press , then press  until Lock menu displays.
2. Enter the current lock codes. To find the current lock codes, follow the instructions under “Configuration and Thermostat Lock”.
3. Press  to enter new lock codes.
4. Enter new lock codes.
5. Press . The Lock Codes have been updated.

**** Note:** Upon subsequent power ups, new lock codes will display.



Configuration Mode

The configuration mode is used to set the thermostat to match your heating/cooling system. The thermostat functions with heat pump, air conditioning, gas, oil, or electric heat systems. To configure the thermostat, perform the following steps:

Press , then press  repeatedly until **MENU**
CONFIG is selected.

Press  to advance from one screen to the next.

**** Note:** Pressing  will return you to the previous screen.

Press the  or  to change settings within each screen. Changes are saved automatically.

To exit configuration mode, press . Auto exit occurs after two minutes with no icons touched.

Configuration Mode Settings

The setup screens for Configuration Mode are as follows:

1. Temperature Scale (F or C)

Choose Fahrenheit or Celsius.

Press the \wedge or \vee to select.

Press \rightarrow to advance to the next screen.

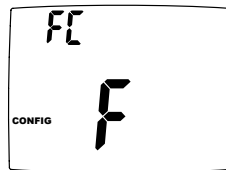

2. 1st Stage Temperature Differential (1°F to 5°F) (0.5°C to 2.5°C)

Set the number of degrees between your "setpoint" temperature and your "turn on" temperature.

Press the \wedge or \vee to set differential value. Press \rightarrow to advance to the next screen.

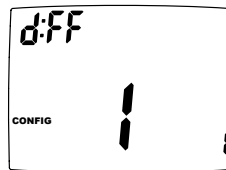

3. 2nd Stage Temperature Differential (1°F to 5°F) (0.5°C to 2.5°C)

**** Note: Not for $\Sigma 1010$**

Set the number of degrees between when stage 1 turns on and when stage 2 turns on.

Press the \wedge or \vee to set differential value. Press \rightarrow to advance to the next screen.

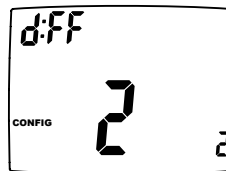

4. Staged Off Outputs

Select whether the outputs for heating and cooling are staged off independently or are satisfied simultaneously.

no = Outputs off simultaneously. **y** = Outputs staged off independently.

Press the \wedge or \vee to set. Press \rightarrow to advance to the next screen.

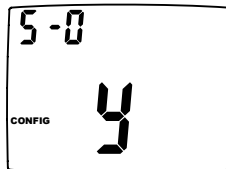

5. Minimum Deadband (1°F to 9°F) (1°C to 5°C)

Set the minimum separation between heat setpoint and cool setpoint in Auto Changeover Mode.

Press the \wedge or \vee to set deadband value.

Press \rightarrow to advance to the next screen.

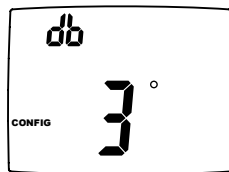

6. Heat Source: There are six heat source settings:

WARNING!: Incorrect settings can damage system and/or cause potentially dangerous conditions. Use the code described in Configuration and Thermostat Lock.

Non-Heat Pump

Electric

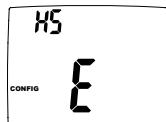

Gas

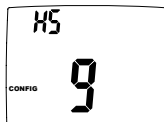

Heat Pump

Heat Pump with
2 compressors
and Heat Active
Reversing Valve

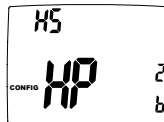

Heat Pump with
1 compressor
and Heat Active
Reversing Valve

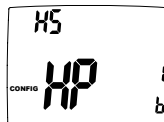

Heat Pump with
2 compressors
and Cool Active
Reversing Valve

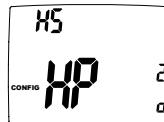

Heat Pump with
1 compressor
and Cool Active
Reversing Valve

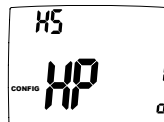

7. Auxiliary Delay ON (0-60 minutes)

Set the delay time in minutes for auxiliary heat to be locked out after a call for second stage. This extra savings feature is used to temporarily lock out auxiliary heat devices, allowing just heat pump to try to satisfy heat call.

Press the \wedge or \vee to select. Press \rightarrow to advance to the next screen.

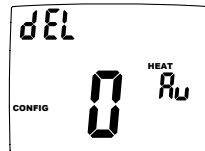

8. Lockout (0-8°, SLEEP, COOL-HEAT)

Select the number of degrees set temperature can be changed during keypad lockout. **SLEEP** setting locks thermostat only during the sleep period to prevent after hours tampering.

COOL-HEAT lockout allows adjustment of the set temperatures to the maximum heat set temperature selected and minimum cool set temperature selected.

**** Note:** *The mode cannot be changed while the thermostat is locked.*

Press the \wedge or \vee to select. Press \blacktriangleright to advance to the next screen.

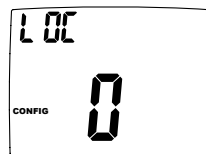

9. Maximum Heat Setpoint (45°F to 90°F) (7°C to 32°C)

Adjust to control the maximum heat set temperature allowed.

Press the \wedge or \vee to select. Press \blacktriangleright to advance to the next screen.

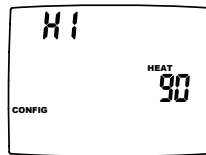

10. Minimum Cool Setpoint (45°F to 90°F) (7°C to 32°C)

Adjust to control the minimum cool set temperature allowed.

Press the \wedge or \vee to select. Press \blacktriangleright to advance to the next screen.

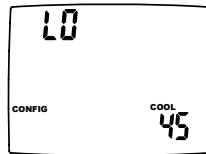

11. Vacation Cooling Setpoint

These work in conjunction with the Schedule mode where you set the date and time of your RETURN from vacation (Page 25).

Until that date/time, system will remain at the cooling setpoint specified here.

Press the \wedge or \vee to select. Press \blacktriangleright to advance to the next screen.

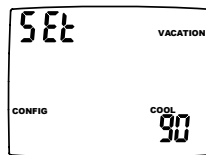

12. Vacation Heating Setpoint

These work in conjunction with the Schedule mode where you set the date and time of your RETURN from vacation (Page 25).

Until that date/time, system will remain at the heating setpoint specified here.

Press the \wedge or \vee to select. Press \blacktriangleright to advance to the next screen.

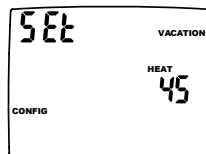

13. Room Temperature Offset (+9°F to -9°F) (+4.5°C to -4.5°C)

Adjust to calibrate displayed room temperature to match actual room temperature.

Press the \wedge or \vee to select.

Press \blackrightarrow to advance to the next screen.

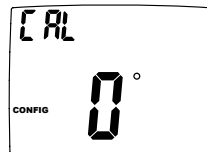

14. Maximum Cycles Allowed Per Hour (-, 2-6)

\bullet \bullet = as many as needed, 2-6 = maximum cycles/hour

Press \wedge or \vee to select.

Press \blackrightarrow to advance to the next screen.

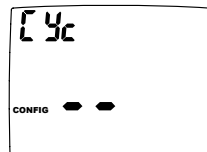

15. Temperature Sensor (L, r, A, r sleep)

**** Note:** *If there is no remote sensor, option 1 (L) must be selected. May only be used with remote temperature sensor 1.*

WARNING!: *Incorrect settings can damage system and/or cause potentially dangerous conditions. Use the code described in Configuration Safety Lock to access this screen setting*

Appears only for non-heat pump systems and heat pumps without an outdoor sensor.

1. **L** – Only on-board sensor determines room temperature.

3. **A** – Average temperature of on-board and remote sensor.

2. **r** – Only remote sensor determines room temperature.

4. **r Sleep** – Only on-board sensor will be used until SLEEP period, and then only remote sensor is used for SLEEP period.

Press \wedge or \vee to select.

Press \blackrightarrow to advance to the next screen.

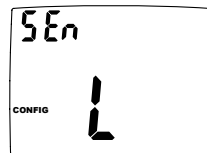

16. Fan Delay Off Time (0, 30, 60, 90 seconds)

Select the amount of time the fan continues to operate after the cool/heat demand has been satisfied. Functions for cooling, heat pumps and electric heat.

Press \wedge or \vee to select.

Press \blackrightarrow to advance to the next screen.

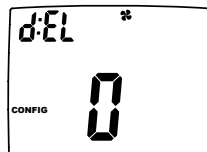

17. Hourly Cycle Fan Operation (1-30 minutes per hour)

Used in conjunction with the Fan HOURLY mode. When the user selects this option, the fan will turn on at the beginning of every hour and run for the number of minutes indicated here.

Press the \wedge or \vee to select. Press \blacktriangleright to advance to the next screen.

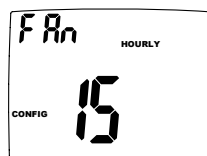

18. Humidification/Dehumidification (Hu, dE)

Set system configuration to work with a humidifier or dehumidifier (including air conditioner).

**** Note:** *Incorrect settings can damage system and/or cause potentially dangerous conditions.*

Use the code described in Configuration Safety Lock to access this screen setting.

Hu: used with a humidifier to humidify home.

dE: used with air conditioner or dehumidifier to de humidify home.

Press the \wedge or \vee to select. Press \blacktriangleright to advance to the next screen.

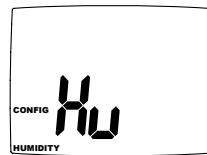

19. Humidity Differential (1% to 10%)

Set the percent difference between the setpoint humidity and when the humidifier or dehumidifier system turns on.

Press the \wedge or \vee to select. Press \blacktriangleright to advance to the next screen.

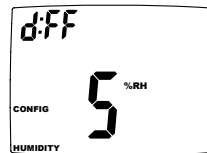

20. Condition to Turn On

Set the condition for system to follow:

Humidification

No = No condition other than humidity reading below setpoint and differential will turn on the humidifier.

HEAT = Heat must be energized in order for the humidifier to turn on.

HEAT-FAN: Either the heat or the fan must be energized in order for the humidifier to turn on.

Dehumidification

No = No condition other than humidity reading above setpoint and differential will turn on the dehumidifier.

COOL-FAN = Either the cooling system or the fan must be energized in order for the dehumidifier to turn on.

COOL-no = Cooling system cannot be energized in order for the dehumidifier to turn on.

Press the \wedge or \vee to select. Press \blacktriangleright to advance to the next screen.

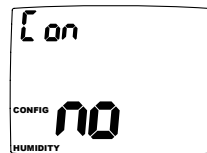

21. **Extended AC** (no, COOL -2 (Fahrenheit), COOL -1 (Celsius))

**** Note:** *Only used for Dehumidification when condition is set to COOL-FAN.*

Set an extended time on the AC to increase dehumidification capabilities.

no = No extended AC time.

COOL -2 or COOL -1 = Cooling system will continue to operate after the set temperature has been reached until the room temperature is 3°F (1.5°C) below the set temperature if dehumidification has not been satisfied.

Press \wedge or \vee to select.

Press \blackrightarrow to advance to the next screen.



22. **Relay Operation (dehumidification only)**

Set the relay function to match your system (normally open, normally closed).

Press the \wedge or \vee to select. Press \blackrightarrow to advance to the next screen.

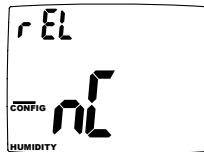

23. **Fan on Schedule** (OFF, WAKE, LEAVE, RETURN, SLEEP)

The fan will run continuously during this scheduled period when the mode is not set to OFF. To turn on the fan during one of the scheduled periods (WAKE, LEAVE, RETURN, SLEEP), please do the following:

Press the \wedge or \vee to select. Press \blackrightarrow to advance to the next screen.

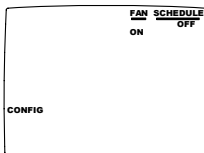

24. **Check Filter Timer** (800-2500 hours)



After the number of (fan running) hours specified, (for example, 1200 hours), the words "CHECK FILTER" will display to remind you to check/change the system filter. The next configuration screen is where the elapsed number of run hours can be reset.

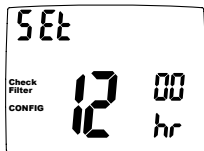

Press the \wedge or \vee to select. Press \blackrightarrow to advance to the next screen.



25. Reset Check Filter Timer

Used to reset the elapsed number of (fan running) hours for the Check Filter Timer

Press  or  to select  (YES).

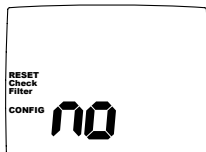

Press  to advance to the next screen or press  to exit configuration setting mode.
Auto exit occurs after two minutes of no icons being touched.



Mode of Operation

The thermostat is a programmable, manual or auto changeover, up to 2-stage heat (depending on your model) and up to 2-stage cool (depending on your model) thermostat. It functions with air conditioning, heat pumps, gas, oil, or electric heat systems. An outdoor sensor can be used to monitor the ambient temperature. A second remote sensor may be used to monitor the temperature in another area. The thermostat activates the heating appliance when the room temperature is below the set heat temperature (by the differential temperature). When the call for heat has been satisfied, the outputs are turned off. With heat pumps, the thermostat will not let the compressor come on for 4 minutes after it turns off to protect your compressor.

When the room temperature is greater than the set cool temperature (by the differential temperature), the cooling device is activated. When the call for cooling has been satisfied, the outputs are turned off. The thermostat will not let the compressor come on for 4 minutes after it turns off to protect your compressor.

The program schedule can be overridden by changing the set temperature ( or ). This puts the thermostat into a temporary hold. It will automatically return to the program schedule at the next program schedule transition.

This thermostat is also capable of controlling a humidifier or dehumidifier. When set to humidification, the thermostat will turn on the humidification system when the relative humidity is lower than the set humidity, by the differential. When the relative humidity reaches the differential humidity set, the thermostat will turn off the humidification system. If the thermostat is controlling a dehumidifier (including an air conditioner), the thermostat will turn on the dehumidifier when the relative humidity is above the setpoint humidity, by the differential. Depending on the settings, when the relative humidity reaches the differential humidity set or the room temperature is 3°F below the set cooling temperature, the dehumidifier is turned off.

Icon Functions

 **UP** – Used to increase the time, set temperatures, and to adjust configuration settings.

 **DOWN** – Used to decrease the time, set temperatures, and to adjust configuration settings.

 **MENU** – Used to enter configuration, set the clock, lock the thermostat, or select viewing options.

CONFIG  Sets up thermostat to work for specific systems

CLOCK  Set year, month, date, and time

LOCK  Allows you to lock the thermostat to prevent tampering

VIEW  Allows you to see both the remote sensor temperatures, date, current schedule period, lock screen, filter accumulated time, and show details (system status).

HUMIDITY  Allows you to view the current relative humidity and change humidity setpoint (10% to 80%).

 **MODE** – Used to select between OFF, HEAT, EMERGENCY HEAT (heat pump only), COOL, and AUTO changeover modes.

 **HOME** – Wakes thermostat, returns to home screen, and enters changes into memory.

 **FAN** – Used to select between AUTO, ON, and HOURLY fan operation.



 **SCHEDULE** – Used to edit program schedule, turn program on and off, and set vacation return dates.

Operating Modes

The possible operating modes for the thermostat are: OFF, HEAT, EM HEAT, COOL, and AUTO. Use  to select.

OFF Mode

• In this mode, the thermostat will not turn on the heating or cooling devices

***Note:** *The indoor fan can be turned on manually in every operating mode by pressing  until **FAN ON** displays. The fan icon  appears on the display when the fan operates.*

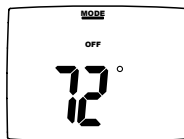

Heat Mode

• In this mode, the thermostat controls the heating system. When the heat outputs, the flame  icon appears on the display for each stage of heat that is on.

***Note:** *For heat pumps, there is a four minute delay for your compressor to restart after it has turned off. To bypass the compressor time delay, go to OFF mode and press .*

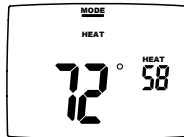

EM Heat Mode

• In this mode, the compressor is bypassed and emergency heat is used.

***Note:** *This mode is only used with one compressor heat pumps.*

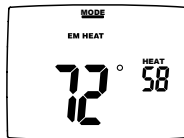

Cool Mode

• In this mode, the thermostat controls the cooling system. When the cooling outputs, the snowflake  icon appears on the display for each stage of cool that is on.

***Note:** *There is a four minute delay for your compressor to restart after it has turned off. To bypass the compressor time delay, go to OFF mode and press .*

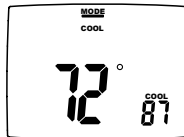

Auto Mode

In this mode, the thermostat controls either the heating or cooling systems automatically, depending on the displayed room temperature and the heat or cool setpoint.

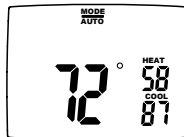



Testing the Thermostat

Once the thermostat is configured, it should be thoroughly tested.



CAUTION!: *Do not energize the air conditioning system when the outdoor temperature is below 50 degrees. It can result in equipment damage or personal injury.*

Heat Test

1. Press , then press  until heat mode is displayed.
2. Adjust the set temperature so it is 5 degrees above the room temperature.
3. Heating should come on within a few seconds.
4. Adjust the set temperature 2 degrees below the room temperature and the heat should turn off. There may be a fan delay on your system.





**** Note:** *For heat pumps, there is a four-minute delay to protect your compressor after it turns off. To bypass the compressor time delay, go to **OFF** mode and press .*

Cool Test

1. Press , then press  until cool mode is displayed.
2. Adjust set temperature so it is 5 degrees below room temperature.
3. Cooling should come on within a few seconds.
4. Adjust the set temperature 2 degrees above the room temperature and the cooling should turn off. There may be a fan delay on your system.

**** Note:** *There is a four-minute time delay to protect the compressor after it turns off. To bypass the compressor time delay, go to **OFF** mode and press .*

Fan Test

1. Press , then press  icon. **FAN ON** displays. Indoor fan turns ON.
2. Press , then press  icon. **FAN AUTO** displays. Indoor fan turns OFF.

Testing the Thermostat Humidity Control



Humidification Test — when set to humidification, only

To test the humidifier, set the mode and fan to the correct setting:

HEAT-FAN: Either the heating system or fan must be operating in order for the humidifier to turn on.

HEAT: Heat must be operating in order for the humidifier to turn on.

no: No condition other than humidity reading below setpoint and differential will turn on humidifier.

1. Go to **MENU/HUMIDITY** and press .
2. Change the humidity setpoint above the relative humidity by the differential (Configuration Menu, Section 19, Page 16).
3. Press  twice. You should hear a click and when you go back into the humidity settings you will see ON in the top left corner of the screen.
4. Change the humidity setting below the relative humidity by the differential. The humidifier will turn off.





Dehumidification Test — when set to dehumidification, only

To test dehumidification, set the mode and fan to the correct settings.



















COOL-FAN: Either the cooling system or fan must be operating in order for the dehumidifier to turn on.

COOL-no: The cooling system must be turned off in order for the dehumidifier to turn on.

no: No condition other than humidity reading above setpoint and differential will turn on dehumidifier.

1. Go to **MENU/HUMIDITY** and press .
2. Change the humidity setpoint below the relative humidity by the differential (Configuration Menu, Section 19, Page 16).
3. Press  twice. If the relay configuration is set to normally open, there will be a click and the humidity screen will display ON. If the relay configuration is set to normally closed, the humidity screen will not display ON.
4. Change the humidity setting to greater than the relative humidity by the differential by pressing the .
5. Press  twice. If the relay configuration is set to normally closed, there will be a click and ON is displayed on the humidity screen. If the relay configuration is set to normally open, the humidity screen will not display ON.























Setting the Time and Date

1. Press , then press  until CLOCK is displayed.
2. Press  to enter date/time setting. Year blinks.
3. Press  or  to select the year.
4. Press  to save value and move to month.
5. Press  or  to select the month.
6. Press  to save value and move to day.
7. Press  or  to select the day.
8. Press  to save value and move to hour.
9. Press  or  to select the hour.
**** Note:** *As you move past 12:00, the AM/PM symbol will change automatically.*
10. Press  to save the value and move to minutes.
11. Press  or  to select the minutes.
12. Press  to exit Time/Date setting.



Setting the Program Schedule

The thermostat has four periods (WAKE, LEAVE, RETURN, SLEEP) that are customizable for each day of the week. Each period will have a start time, heat temperature, and cool temperature. The thermostat monitors the day and time, while maintaining the specific conditions you have chosen for each period in your program.

Setting the program schedule:

1. Press , then press  until EDIT is displayed.
 2. Press  to enter Program Schedule.
 3. The day of the week flashes. Use the  or  to select the day of the week.
**** Note:** *You can select the days individually, or if you keep going, there is an option for MON-FRI, MON-SUN or SAT-SUN.*
 4. Press  to continue.
 5. The period (WAKE, LEAVE, RETURN, SLEEP) begins flashing. Use the  or  to select the desired period.
 6. Press  to continue.
 7. Hour flashes. Use the  or  to select the hour when you want the current period to begin.
 8. Press  to continue.
 9. The minutes flash. Use the  or  to select the minutes when you want the current period to begin.
 10. Press  to continue.
 11. The HEAT temperature flashes. Use the  or  to set the desired heat temperature.
 12. Press  to continue.
 13. The COOL temperature flashes. Use the  or  to set the desired cool temperature.
 14. Press  to continue.
- Continue to set your entire schedule.
- Press  to exit.

View Screen Options



Press , then press  repeatedly until the **MENU VIEW** option displays then press .

Press  to advance to the next screen.

Press  to go to previous screen.

**** Note:** *These screens are visible when the thermostat is locked or unlocked.*

View REMOTE SENSOR 1 temperature

  if not used.

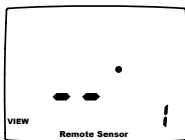

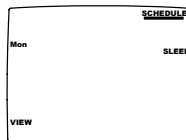

View program schedule settings

- **OFF** shows when schedule is off.
- **SETTINGS** show when schedule is on.



View REMOTE SENSOR 2 temperature

  if not used.

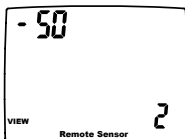

View if locked or unlocked

no = Unlocked
y = Locked

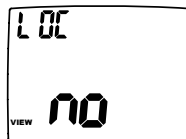

View month, day, and year

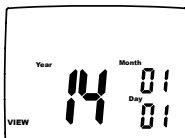

View filter status

Accumulated fan run time displays.

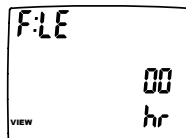

Display setpoints, fan, and program information

Press or to select. = Don't display setpoints and program schedule information.

= Always display setpoints and program schedule information.

REMOTE SENSOR 1 = REMOTE SENSOR 1 temperature will display.

REMOTE SENSOR 2 = REMOTE SENSOR 2 temperature will display.

Press to exit.

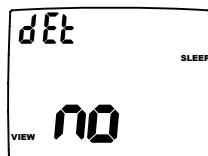

Schedule Override

The schedule override feature allows the user to override the program schedule for 1 to 5 hours. In addition, if selected, the schedule can be overridden only until the next transition period.

To access the Schedule override feature, enter the screen, then use to scroll through the menu options until you reach the SCHEDULE OVERRIDE screen. In the default setting, the Vacation & Schedule periods will be flashing in the upper right corner of the LCD. In this mode, the Vacation & Schedule will be overridden until the next transition period. To switch to the 1-5 hour override, use the arrow. This mode allows the user to override the Schedule set points for 1-5 hours.

Setting the Vacation Timer

The vacation timer lets you set the date and time of your RETURN from vacation. Until that date/time, the system will remain at the VACATION heating and cooling setpoints specified in the configuration menu.

To use the EASY VACATION feature:

Press , then press the to scroll to "Vacation" then press again. The thermostat will automatically go into Vacation mode with the default return date 1 month later .

To set the vacation timer (and begin vacation setpoint mode):

1. Press to select operating mode.
2. Press , then press until VACATION appears.
3. Press to enter the date and time you plan to RETURN from vacation.
4. When your finished entering the date/time, press .

Factory Preprogramming

The thermostat comes pre-programmed with the following schedule:

**MONDAY
thru
SUNDAY**





WAKE	6:00 AM
HEAT	70°F
COOL	78°F

LEAVE	8:00 AM
HEAT	62°F
COOL	85°F









RETURN	6:00 PM
HEAT	70°F
COOL	78°F

SLEEP	10:00 PM
HEAT	62°F
COOL	82°F

Troubleshooting

Symptom	Remedy
No display	Check for 24 VAC at thermostat; display is blank when 24 VAC is not present. Time and day of week must be reset after power loss with no batteries installed.
System fan does not come on properly	Verify wiring is correct, check heat source (Gas/Electric) in Configuration (see Section 6, Page 13).
No response with first button press	Press  to activate touch icons.
Program schedule activates at wrong time	Check time (AM/PM) set on thermostat (see Setting the Time & Date, Page 23).
Thermostat turns on/off too frequently	Adjust temperature differential (see Configuration Mode Setting, Section 2, Page 11).
Thermostat does not follow program	Verify the schedule is on  SCHEDULE ON : check time (AM/PM); check if in program override.
Fan runs continuously	Press  and set to auto FAN AUTO . FAN ON is continuous run.
Room temperature is not correct	Calibrate thermostat (see Configuration Mode Setting, Section 13, Page 15). If remote sensor is used, check S1 and S2 terminal connections.
LOCK displays when any button is pressed	Thermostat has the button lockout function activated (see Lockout & Unlock Feature, Page 10).
  on display instead of room temp.	Check for a bad connection at S1 and S2 terminals.

Troubleshooting (continued)

Symptom	Remedy
Heat or Cool not coming on	Verify wiring is correct, gently pull on each wire to verify there is a good connection at terminal block.
Setpoints do not display all of the time	 Press  MENU VIEW ,  six times, 
Er displays	Check for low battery condition or faulty outdoor/remote temperature sensor.
Remote Sensor displays	Check remote sensors temperature at   MENU VIEW ,  .
OVERRIDE displays	Program schedule is in temporary override, it will return to schedule at the next transition time.
Condensation forming on windows	Decrease humidification setting
Thermostat says that the humidifier is operating but humidity has not risen	Check humidifier pad and replace if necessary
Dehumidifier is always running	Check the relay configuration (Section 22, Page 17).
The room temperature is met, but the air conditioner is still operating	Dehumidification is set to COOL -2. The thermostat will continue to let the cooling system operate until the cooling temperature is 3°F below the setpoint or when the dehumidification setpoint is met.
Offline 	If the thermostat or APP shows offline () for more than a few minutes, unplug the thermostat from the wall plate, wait one minute, then plug thermostat back into wall plate.

FIVE-YEAR LIMITED WARRANTY

The Seller warrants its products against defects in material or workmanship for a period of five (5) years from the date of manufacture. The liability of the Seller is limited, at its option, to repair, replace or issue a non-case credit for the purchase prices of the goods which are provided to be defective. The warranty and remedies set forth herein do not apply to any goods or parts thereof which have been subjected to misuse including any use or application in violation of the Seller's instructions, neglect, tampering, improper storage, incorrect installation or servicing not performed by the Seller. In order to permit the Seller to properly administer the warranty, the Buyer shall: 1) Notify the Seller promptly of any claim, submitting date code information or any other pertinent data as requested by the Seller. 2) Permit the Seller to inspect and test the product claimed to be defective. Items claimed to be defective and are determined by Seller to be non-defective are subject to a \$30.00 per hour inspection fee. This warranty constitutes the Seller's sole liability hereunder and is in lieu of any other warranty expressed, implied or statutory. Unless otherwise stated in writing, Seller makes no warranty that the goods depicted or described herein are fit for any particular purpose.



Patent 6,597,275 – Thermal Intrusion Barrier
Patent Pending 14,307,628 – DC Thermostat with Low Battery Response
Patent Pending 14,307,650 – DC Thermostat with Latching Relay Repulsing

7313 William Barry Blvd., North Syracuse, NY 13212
(Toll Free) 800-365-5525 (Phone) 315-233-5266 (Fax) 315-233-5276

www.icmcontrols.com