

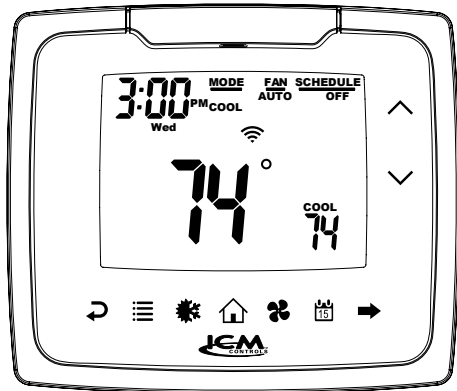

Programmable Thermostat Auto Changeover

BTM **Wi-Fi Thermostat**

- 7-Day, 5-2-Day, or 5-1-1- Day Programmable
- Configurable for Multiple Systems
- Large Display with Backlight
- Selectable Fahrenheit or Celsius
- Icon Indicator Lights
- Relay Outputs – Minimum Voltage Drop in Thermostat
- Remote Sensor Compatible
- Ideally Suited for:
 - Residential (New Construction/Replacement)
 - Light Commercial
- Works with two-transformer systems



Thermostat ID Here

Installation, Operation & Application Guide

For more information on our complete range of American-made products, wiring diagrams, troubleshooting tips, and more, please visit us at www.icmcontrols.com



Thermostat Controls

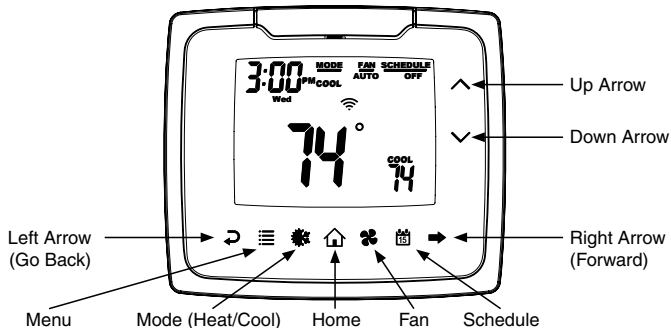

Package Contents/Tools Required

Package includes: Thermostat, base, wiring labels, screws, wall anchors, and *Installation, Operation and Application Guide*.

Tools required for installation: Drill with 3/16" bit, hammer, screwdriver

Specifications

Electrical Rating: 24 VAC (18-30 VAC), 1 amp maximum per output terminal, 5 amp maximum total load

Temperature Control Range: 45°F to 90°F (7°C to 32°C) Accuracy: $\pm 1^\circ\text{F}$ ($\pm 0.5^\circ\text{C}$)

Anti-short Cycle: 4 minutes (bypass anti-short cycle delay by returning to OFF mode and pressing the  icon).

Backlight Operations: 15 seconds



System Configurations: All may be used with heat pump, gas, oil, electric, and air conditioning

- I1010WR: 1-stage heat, 1-stage cool
- I2010WR: 2-stage heat, 1-stage cool
- I2020WR: 2-stage heat, 2-stage cool
- I3020WR: 3-stage heat, 2-stage cool

Mode of Operation

The thermostat is a programmable, manual or auto changeover, up to 3-stage heat (depending on your model) and up to 2-stage cool (depending on your model) thermostat. It functions with air conditioning, heat pumps, gas, oil, or electric heat systems. Some thermostats are dual fuel compatible and an outdoor sensor can be used to monitor the ambient temperature. A second remote sensor may be used to monitor the temperature in another area. The thermostat activates the heating appliance when the room temperature is below the set heat temperature (by the differential temperature). When the call for heat has been satisfied, the outputs are turned off. With heat pumps, the thermostat will not let the compressor come on for 4 minutes after it turns off to protect your compressor.

When the room temperature is greater than the set cool temperature (by the differential temperature), the cooling device is activated. When the call for cooling has been satisfied, the outputs are turned off. The thermostat will not let the compressor come on for 4 minutes after it turns off to protect your compressor.

The program schedule can be overridden by changing the set temperature ( or ). This puts the thermostat into a temporary hold. It will automatically return to the program schedule at the next program schedule transition. To remove the temporary hold before the next schedule transition, press  icon twice.

The thermostat is also Wi-Fi compatible. After you connect your thermostat to your wireless network, you can monitor and control your thermostat using the app (available for most devices) or a computer connected to the internet.

Icon Functions

- ∧ **UP** – Used to increase the time, set temperatures, and to adjust configuration settings.
- ∨ **DOWN** – Used to decrease the time, set temperatures, and to adjust configuration settings.
- ☰ **MENU** – Used to enter configuration, set the clock, lock the thermostat, or select viewing options.
 - CONFIG ➡ Sets up thermostat to work for specific systems.
 - CLOCK ➡ Set year, month, date, and time.
 - WEATHER ➡ Shows the highs and lows for three days.
 - LOCK ➡ Allows you to lock the thermostat to prevent tampering.
 - VIEW ➡ Allows you to see both the remote sensor temperatures, date, current schedule period, lock screen, filter accumulated time, and show details (system status).
- 🌀 **FAN** – Used to select between AUTO, ON, and HOURLY fan operation.
- ☀️ **MODE** – Used to select between OFF, HEAT, EMERGENCY HEAT compressor (heat pump only), COOL, and AUTO changeover modes.
- 🏠 **HOME** – Wakes thermostat, returns to home screen, and enters changes into memory.
- 📅 **SCHEDULE** – Used to edit program schedule, turn program on and off, and set vacation return dates.
- 📶! **Flashing** – The thermostat is in Setup Mode and is searching for a wireless network.
- 📶 **Flashing** – Wi-Fi is busy.
- 📶! **Solid** – The thermostat is not connected to Wi-Fi. If the thermostat has successfully connected to Wi-Fi previously, and no new conditions exist (i.e. password change, wireless router change), the thermostat will automatically reconnect—otherwise the thermostat will have to be reconnected to the wireless network manually.
- 📶 **Solid** – The thermostat is connected to Wi-Fi.

Important Safety Information

WARNING!: Always turn off power at the main power supply before installing, cleaning, or removing thermostat.

- This thermostat is for 24 VAC applications only; do not use on voltages over 30 VAC.
- Do not short across terminals of gas valve or system control to test operation; this will damage your thermostat and void your warranty.
- All wiring must conform to local and national electrical and building codes.
- Do not use air conditioning when the outdoor temperature is below 50 degrees; this can damage your A/C system and cause personal injuries.
- Use this thermostat only as described in this manual.

To Remove Existing Thermostat



ELECTRICAL SHOCK HAZARD – Turn off power at the main service panel by removing the fuse or switching the appropriate circuit breaker to OFF position before removing the existing thermostat.

1. Turn off power to heating & cooling system by removing the fuse or switching the appropriate circuit breaker off.
2. Remove cover of old thermostat; this should expose the wires.
3. Label the existing wires with the enclosed wire labels before removing wires.
4. After labeling wires, remove wires from wire terminals.
5. Remove existing thermostat base from wall.
6. Refer to the following section for instructions on how to install this thermostat.

To Install Thermostat



ELECTRICAL SHOCK HAZARD – Turn off power at the main service panel by removing the fuse or switching the appropriate circuit breaker to OFF position before installing new thermostat.

IMPORTANT: Thermostat installation must conform to local and national building and electrical codes and ordinances.

*** Note:** Mount the thermostat about five feet above the floor. Do not mount the thermostat on an outside wall, in direct sunlight, behind a door, or in an area affected by a vent or duct.

1. Turn off power to heating & cooling system by removing the fuse or switching the appropriate circuit breaker off.
 2. Put thermostat sub base against the wall where you plan to mount it (be sure wires will feed through the wire opening in the sub base of the thermostat).
 3. Mark the placement of the mounting holes.
 4. Set thermostat sub base and thermostat away from working area.
 5. Using a 3/16" drill bit, drill holes in the places you have marked for mounting.
 6. Use a hammer to tap supplied anchors in mounting holes.
 7. Use supplied screws to mount thermostat sub base to wall (make sure thermostat wire is through hole).
 8. Insert stripped, labeled wires in matching wire terminals. Tighten screws to secure wires.
- CAUTION!** Be sure exposed portion of wires do not touch other wires.
9. Gently tug wire to be sure of proper connection. Double check that each wire is connected to the proper terminal.
 10. Snap thermostat onto the sub base.
 11. Turn on power to the system at the main service panel.
 12. Configure thermostat to match the type of system you have.
 13. Connect thermostat to wireless network.
 14. Test thermostat operation as described in "Testing the Thermostat".

*** Note:** Upon Power-up the thermostat will not activate outputs for four minutes. To bypass the output lockout, change the setpoint temperature in heat or cool mode on the thermostat, by the temperature differential.

Terminal Designator Descriptions

SC, S1, S2 – Remote sensor or outdoor sensor

RC, RH – 24 VAC hot

C – 24 VAC common

Y1 – 1st stage cool, 1st stage heat for heat pumps

Y2 – 2nd stage cool for 2-compressor systems. 2nd stage heat for 2-compressor heat pump systems.

G – Fan

W1/O/B – Configurable

W1 – 1st stage heat for non-heat pump systems

O – Cool active reversing valve

B – Heat active reversing valve

W2 – 2nd stage heat for 1 compressor heat pump and non-heat pump

AUX – 3rd stage heat

**** Note:** *Not all terminals are used in every model.*

Wiring Diagrams

1010WR Heating/Cooling

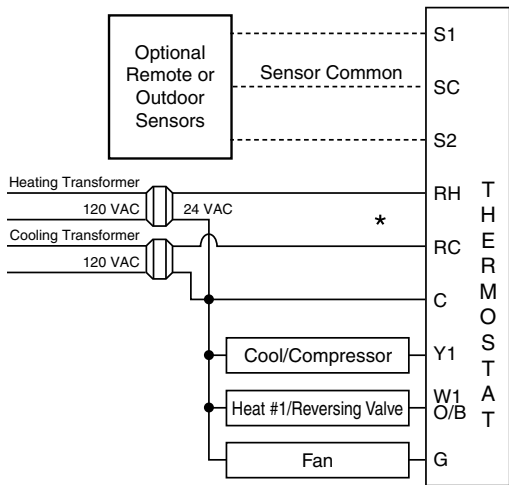

2010WR Heating/Cooling

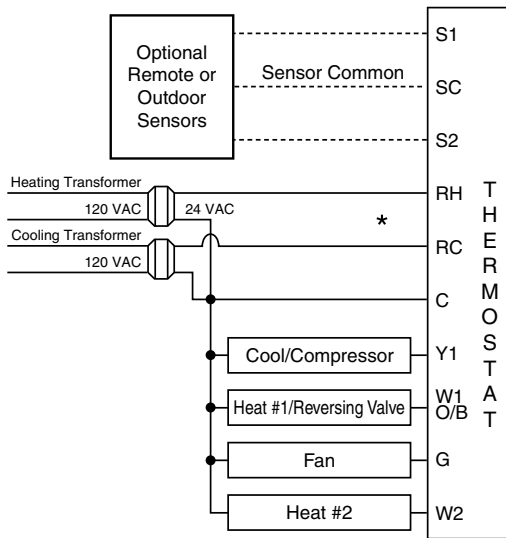

* Remove factory-installed jumper for systems with two transformers.

** **Note:** *Not all terminals may be used with every model.*

Wiring Diagrams (continued)

⚡ 2020WR Heating/Cooling

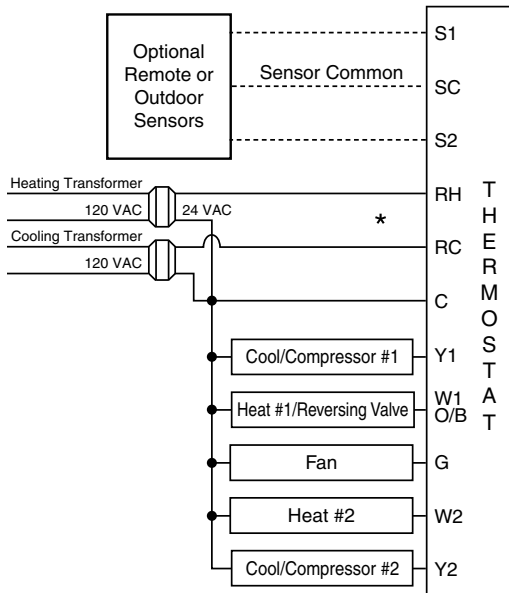

⚡ 3020WR Heating/Cooling

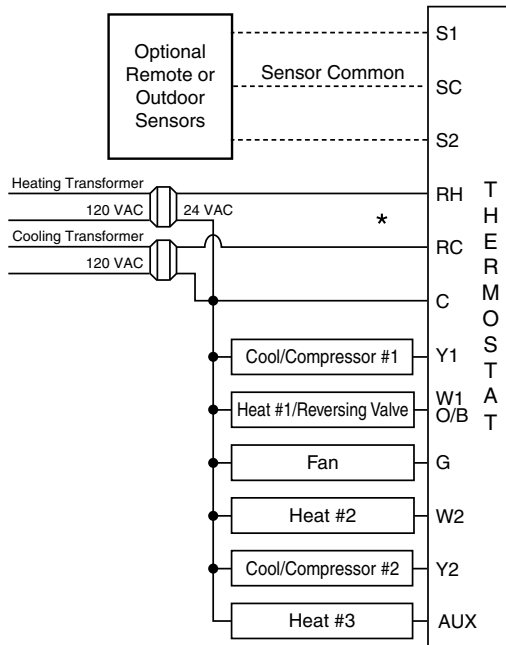

* Remove factory-installed jumper for systems with two transformers.

** **Note:** *Not all terminals may be used with every model.*

Remote Sensor Installation (Optional)

Terminals S1, S2, and SC are used with remote sensors. S1 can be used with a remote sensor to monitor indoor or outdoor temperatures. An outdoor remote sensor can be used to change system operation based on the outdoor temperature with heat pumps with gas/oil backup or heat pumps with electric backup. An indoor remote sensor is used to read the indoor temperature in a different location. This is beneficial when the thermostat is not mounted in the ideal location.

S2 is a 10kΩ NTC thermistor sensor that can only monitor the temperature in a different area.

1. Remove cover from remote sensor housing.
2. Select an appropriate location for mounting the remote sensors.
3. Mount the remote sensors using hardware provided.
4. Install two-strand shielded wire between the S1 terminal on the remote sensor and the S1 terminal on the thermostat.
5. Install two-strand shielded wire between the 10kΩ NTC remote sensor and the S2 terminal on the thermostat.
6. From both remote sensors, install a two-strand shielded wire from their common to the SC terminal on the thermostat.
7. Configure the thermostat to work with the remote sensor.

Ordering Information:

Remote Sensor 1

- Indoor remote sensor: **ACC-RT104**
- Outdoor remote sensor: **ACC-OD104**

Remote Sensor 2

- 10kΩ NTC thermistor sensor

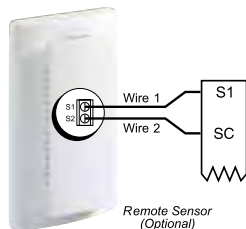

** Note:

Remote or outdoor sensor reading can be displayed by

pressing the icon.

Press , select **MENU VIEW**
press

1010R Output Chart

	1 ST Cool	1 ST Heat
Heat/Cool	Y1, G	W1, G*
Heat Pump (One Compressor)	Y1, G, O	Y, G, B

* G not on for gas/oil systems

2010WR Output Chart

	1 ST Cool	1 ST Heat	2 ND Heat
Heat/Cool	Y1, G	W1, G*	W1, W2, G*
Heat Pump (One Compressor)	Y1, G, O	Y1, G, B	Y1, G, B, W2
Emergency Heat (Heat Pump Only)	N/A	W2, G	N/A

* G not on for gas/oil systems

2020WR Output Chart

	1 ST Cool	2 ND Cool	1 ST Heat	2 ND Heat
Heat/Cool	Y1, G	Y1, Y2, G	W1, G*	W1, W2, G*
Heat Pump (One Compressor)	Y1, G, O	Y1, G, O	Y1, G, B	Y1, W2, G, B
Heat Pump (Two Compressors)	Y1, G, O	Y1, Y2, G, O	Y1, G, B	Y1, Y2, G, B
Emergency Heat (Heat Pump Only)	N/A	N/A	W2, G	N/A

* G not on for gas/oil systems

3020WR Output Chart

	1 ST Cool	2 ND Cool	1 ST Heat	2 ND Heat	3 RD Heat
Heat/Cool	Y1, G	Y1, Y2, G	W1, G*	W1, W2, G*	W1, W2, AUX, G*
Heat Pump (One Compressor)	Y1, G, O	Y1, G, O	Y1, G, B	Y1, W2, G, B	Y1, W2, AUX, G, B
Heat Pump (Two Compressors)	Y1, G, O	Y1, Y2, G, O	Y1, G, B	Y1, Y2, G, B	Y1, Y2, W2, G, B
Dual Fuel (One Compressor)	Y1, G, O	Y1, G, O	Y1, G, B	W2	W2, AUX
Dual Fuel (Two Compressors)	Y1, G, O	Y1, Y2, G, O	Y1, G, B	Y1, Y2, G, B	W2
Emergency Heat (Heat Pump Only)	N/A	N/A	W2, G	W2, AUX**, G	N/A

* G not on for gas/oil systems

** One compressor only

The thermostat is configurable for all systems. The configuration directly affects the outputs. Use the output chart to correctly configure and wire the thermostat to your system.

Configuration and Thermostat Lock

During Configuration Mode, certain settings are protected by a numeric code access screen to prevent unintentional changes that could potentially damage the system or create a dangerous condition.

Whenever changes are attempted to one of the critical settings, the unlock code screen will appear:



The unlock code for these critical settings can be found during the power-up sequence.

The large number (indicated by "98" in the diagram) is the code that will unlock the desired configuration setting.

The smaller numbers (indicated by "93" and "82" in the diagram) are codes used to lock and unlock your thermostat to prevent tampering.

To view the default codes for your thermostat, remove the thermostat from the sub base for 10 seconds. Reinstalling thermostat will cause the codes to display for approximately 5 seconds.

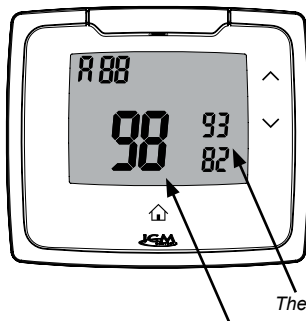



Write your codes here

Thermostat lock code

Configuration safety lock code

Locking & Unlocking Thermostat

To lock and unlock thermostat, perform the following steps:

Press , then , then **MENU LOCK**, then 

Use  &  to select digit.



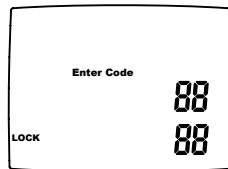

Use  &  to set number.

Press  to lock or unlock.



Changing the Lock Code

To change the lock code, do the following:

1. Press , then press  until Lock menu displays.
2. Enter the current lock codes. To find the current lock codes, follow the instructions under “Configuration and Thermostat Lock”.
3. Press  to enter new lock codes.
4. Enter new lock codes.
5. Press . The Lock Codes have been updated.

**** Note:** Upon subsequent power ups, new lock codes will display.



Configuration Mode

The configuration mode is used to set the thermostat to match your heating/cooling system. The thermostat functions with heat pump, air conditioning, gas, oil, or electric heat systems. To configure the thermostat, perform the following steps:

Press , then press  repeatedly until **MENU**
CONFIG is selected.

Press  to advance from one screen to the next.

**** Note:** Pressing  will return you to the previous screen.

Press the  or  to change settings within each screen. Changes are saved automatically.

To exit configuration mode, press . Auto exit occurs after two minutes with no icons touched.

Configuration Mode Settings

The setup screens for Configuration Mode are as follows:

1. Temperature Scale (F or C)

Choose Fahrenheit or Celsius.

Press the \wedge or \vee to select.

Press \rightarrow to advance to the next screen.

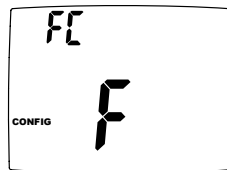

2. 1st Stage Temperature Differential (1°F to 5°F) (0.5°C to 2.5°C)

Set the number of degrees between your "setpoint" temperature and your "turn on" temperature.

Press the \wedge or \vee to set differential value.

Press \rightarrow to advance to the next screen.

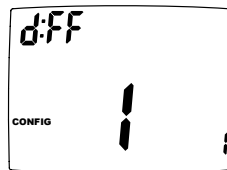

3. 2nd Stage Temperature Differential (1°F to 5°F) (0.5°C to 2.5°C)

**** Note: Not for $\mathbb{E}1010W$**

Set the number of degrees between when stage 1 turns on and when stage 2 turns on.

Press the \wedge or \vee to set differential value.

Press \rightarrow to advance to the next screen.

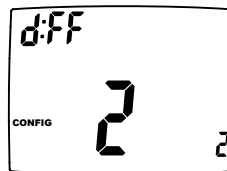

4. 3rd Stage Temperature Differential (1°F to 5°F) (0.5°C to 2.5°C)

**** Note: Only for $\mathbb{E}3020W$**

Set the number of degrees between when stage 2 turns on and when stage 3 turns on.

Press the \wedge or \vee to set differential value.

Press \rightarrow to advance to the next screen.

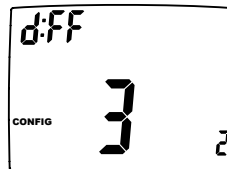

5. Staged Off Outputs

Select whether the outputs for heating and cooling are staged off independently or are satisfied simultaneously.

no = Outputs off simultaneously (best for dual fuel). **y** = Outputs staged off independently.

**** Note:** For 2 compressor heat pumps and multi-stage gas/oil systems, stage 3 is staged off independently when SO is set to **no**.

Press the \wedge or \vee to set.

Press \rightarrow to advance to the next screen.

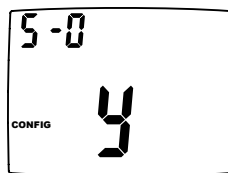

6. Minimum Deadband (1°F to 9°F) (1°C to 5°C)

Set the minimum separation between heat setpoint and cool setpoint in Auto Changeover Mode.

Press the \wedge or \vee to set deadband value.

Press \rightarrow to advance to the next screen.

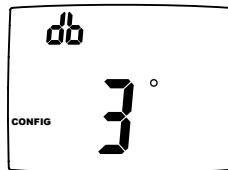

7. Heat Source: There are six heat source settings:

WARNING!: Incorrect settings can damage system and/or cause potentially dangerous conditions. Use the code described in Configuration and Thermostat Lock.

Non-Heat Pump

Electric

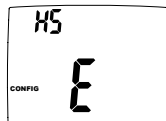

Gas

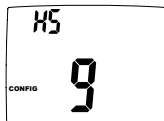

Heat Pump

Heat Pump with 2 compressors and Heat Active Reversing Valve

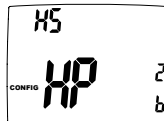

Heat Pump with 2 compressors and Cool Active Reversing Valve

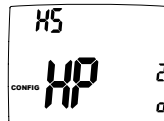

Heat Pump with 1 compressor and Heat Active Reversing Valve

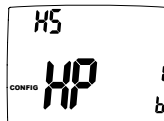

Heat Pump with 1 compressor and Cool Active Reversing Valve

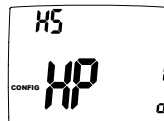

8. *Dual Fuel System (Y 1, Y2, n0)

Appears only if heat pump is selected. For non-heat pump users, please skip this section and advance to the Auxiliary Delay screens on Page 16.

Y 1 = Heat pump with gas/oil furnace back up (see below).

Y2 = Heat pump with gas/oil furnace back up, but furnace can turn on during warm outdoor conditions (see below).

n0 = Heat pump with electric backup (see below).

Press the \wedge or \vee to select. Press \blackrightarrow to advance to the next screen.

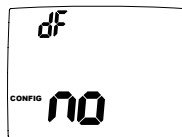

Remote Sensor When Used as Outdoor Sensor (E3020 only)

For Heat Pumps With Electric Backup (DF = n0)

When the ambient temperature is above the selected temperature, the heat pump will operate and electric backup will be locked out. Ambient temperature between the selected temperatures will result in heat pump and electric back-up operation.

Ambient temperature below the lower selected temperature will result in only electric backup operating.

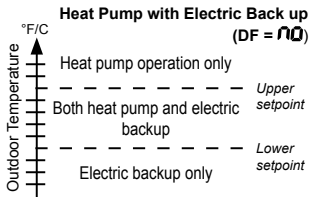

For Heat Pumps With Gas/Oil Backup (DF = Y 1)

When the ambient temperature is above selected temperature, only the heat pump will operate.

When the ambient temperature is below the selected temperature, the heat pump will be locked out and only the furnace will operate.

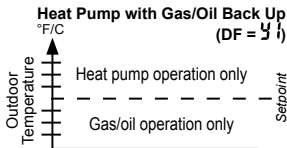

For Heat Pumps With Gas/Oil Backup (DF = Y2)



When the ambient temperature is above selected temperature, heat pump operates with auxiliary stage of gas or oil heat.

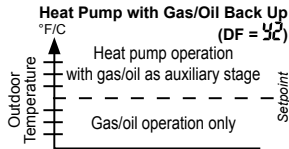

When the ambient temperature is below the selected temperature, the heat pump will be locked out and only the furnace will operate.



9. **Outdoor Upper Setpoint** (50°F to 25°F, --) (10°C to -4.0°C, --)

WARNING!: *Incorrect settings can damage system and/or cause potentially dangerous conditions. Use the code described in Configuration Safety Lock.*

** Note: *Select upper setpoint for chart on previous page. Select   to disable.*

Press the  or  to select.

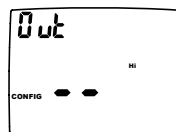

Press  to advance to the next screen.



10. **Outdoor Lower Setpoint** (select -- to disable)

Appears only for heat pump with electric backup with outdoor upper setpoint enabled.

** Note: *Select lower setpoint for chart on previous page.*

Press the  or  to select temperature.

Press  to advance to the next screen.

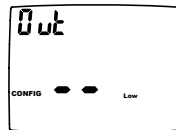

11. **Auxiliary Delay ON** (0-60 minutes)

Set the delay time in minutes for auxiliary heat to be locked out after a call for second stage. This extra savings feature is used to temporarily lock out auxiliary heat devices, allowing just heat pump to satisfy heat call.

Press the  or  to select.

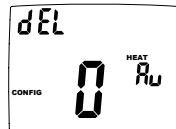

Press  to advance to the next screen.



12. **Lockout** (0-8°, SLEEP, COOL-HEAT)

Select the number of degrees set temperature can be changed during keypad lockout. **SLEEP** setting locks thermostat only during the sleep period to prevent after hours tampering. **COOL-HEAT** lockout allows adjustment of the set temperatures to the maximum heat set temperature selected and minimum cool set temperature selected.

** Note: *The mode cannot be changed while the thermostat is locked.*

Press the  or  to select.

Press  to advance to the next screen.

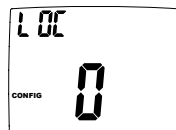

13. **Maximum Heat Setpoint** (45°F to 90°F) (7°C to 32°C)

Adjust to control the maximum heat set temperature allowed.

Press the  or  to select.

Press  to advance to the next screen.

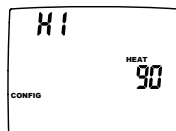

14. **Minimum Cool Setpoint** (45°F to 90°F) (7°C to 32°C)

Adjust to control the minimum cool set temperature allowed.

Press the \wedge or \vee to select.

Press \blacktriangleright to advance to the next screen.

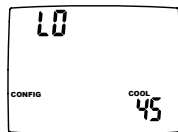

15. **Vacation Cooling Setpoint**

These work in conjunction with the Schedule mode where you set the date and time of your RETURN from vacation (Page 28).

Until that date/time, system will remain at the cooling setpoint specified here.

Press the \wedge or \vee to select.

Press \blacktriangleright to advance to the next screen.

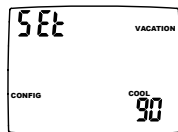

16. **Vacation Heating Setpoint**

These work in conjunction with the Schedule mode where you set the date and time of your RETURN from vacation (Page 28).

Until that date/time, system will remain at the heating setpoint specified here.

Press the \wedge or \vee to select.

Press \blacktriangleright to advance to the next screen.

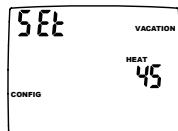

17. **Room Temperature Offset** (+9°F to -9°F) (+4.5°C to -4.5°C)

Adjust to calibrate displayed room temperature to match actual room temperature.

Press the \wedge or \vee to select.

Press \blacktriangleright to advance to the next screen.

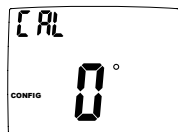

18. **Maximum Cycles Allowed Per Hour** (-, 2-6)

\bullet \bullet = as many as needed, 2-6 = maximum cycles/hour

Press \wedge or \vee to select.

Press \blacktriangleright to advance to the next screen.

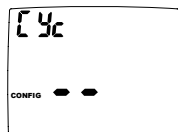

19. Temperature Sensor (L, r, A, r sleep)

**** Note:** If there is no remote sensor, option 1 (L) must be selected. May only be used with remote temperature sensor 1.

WARNING!: Incorrect settings can damage system and/or cause potentially dangerous conditions. Use the code described in Configuration Safety Lock to access this screen setting.

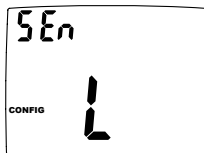

Appears only for non-heat pump systems and heat pumps without an outdoor sensor.

1. **L** – Only on-board sensor determines room temperature.

2. **r** – Only remote sensor determines room temperature.

3. **A** – Average temperature of on-board and remote sensor.

4. **r Sleep** – Only on-board sensor will be used until SLEEP period, and then only remote sensor is used for SLEEP period.

Press the \wedge or \vee to select. Press \rightarrow to advance to the next screen.

20. Fan Delay Off Time (0, 30, 60, 90 seconds)

Select the amount of time the fan continues to operate after the cool/heat demand has been satisfied. Functions for cooling, heat pumps and electric heat.

Press \wedge or \vee to select.

Press \rightarrow to advance to the next screen.

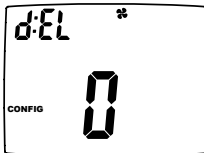

21. Hourly Cycle Fan Operation (1-30 minutes per hour)

Used in conjunction with the Fan HOURLY mode. When the user selects this option, the fan will turn on at the beginning of every hour and run for the number of minutes indicated here.

Press \wedge or \vee to select.

Press \rightarrow to advance to the next screen.

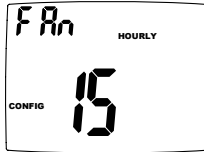

22. Fan on Schedule (OFF, WAKE, LEAVE, RETURN, SLEEP)

The fan will run continuously during this scheduled period when the mode is not set to OFF. To turn on the fan during one of the scheduled periods (WAKE, LEAVE, RETURN, SLEEP), please do the following:

Press \wedge or \vee to select.

Press \rightarrow to advance to the next screen.

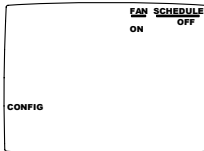

23. Check Filter Timer (800-2500 hours)

After the number of (fan running) hours specified (for example, 1200 hours), the words “CHECK FILTER” will display to remind you to check/change the system filter. The next configuration screen is where the elapsed number of run hours can be reset.

Press \wedge or \vee to select.

Press \rightarrow to advance to the next screen.



24. Reset Check Filter Timer

Used to reset the elapsed number of (fan running) hours for the Check Filter Timer.

Press \wedge or \vee to select Y (YES).

Press \rightarrow to advance to the next screen.

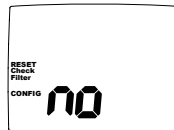

25. Wi-Fi Reset

After installation, you will have to reset Wi-Fi on your thermostat to connect to the wireless network for the first time. If you have previously connected the thermostat to the wireless network but have changed your password or installed a new wireless router, you will have to manually reconnect the thermostat to the wireless network as if for the first time.

**** Note:** *If the thermostat has been connected to a wireless network before, the reset Wi-Fi configuration will be the last screen in the Configuration Menu. To easily access the screen*

*go to **MENU CONFIG** and press \rightarrow . Then press \leftarrow once – the reset Wi-Fi screen will display.*

Press \wedge to select Y (YES), the Wi-Fi icon will start flashing. Press Home to exit configuration setting mode.

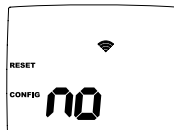

Wi-Fi Setup

The **3E** thermostat is compatible with any wireless network. Connect thermostat to a wireless network, using the following steps:

Create Account

Before connecting your thermostat to a Wi-Fi network, you must create a user account. You can create an account through the app on your smart device, or through the website: <http://www.captouchwifi.com>.

Connecting Your Thermostat to Wi-Fi

There are three different methods you can use to connect your thermostat to a wireless network: using an Apple device, an Android device, or a computer with Wi-Fi capabilities.

**** Note:** *If you are installing the thermostat for someone else, you can transfer the thermostat to the owner, using the app and the owner's email address.*

Using an Apple Device

1. Download the app from the Apple App store by searching "ICM i3™ Thermostat".
2. Reset Wi-Fi on thermostat. To reset Wi-Fi, please follow the steps under Wi-Fi Reset on Page 19.
3. Go to SETTINGS on your Apple device and select **Wi-Fi**.
4. In the list of available networks; select the network named: ICM_I3_XXXXXXXXXX (x's indicate thermostat ID). A checkmark will appear next to the network when connected.
5. Re-enter the app and follow the prompts to connect your thermostat to the wireless network.

Using an Android Device

There are three ways to connect your thermostat to the wireless network using the Android app: adding a new thermostat, using the thermostat wireless network, and using a thermostat already listed in your account.

**** Note:** *Before continuing, download app by searching "ICM i3™ Thermostat" in the app store.*

1. Adding a new thermostat:

- a. Open the app and sign into your account.
- b. Select **"Add new thermostat"**.
- c. Enter the thermostat ID found on a label affixed to the back of the thermostat above the terminals and on the front of this book.
- d. Reset Wi-Fi on thermostat. To reset Wi-Fi, please follow the steps under Wi-Fi Reset on Page 19.
- e. Follow the prompts to connect the thermostat to the wireless network.

2. Using the thermostat to connect to the wireless network:



- a. Reset Wi-Fi on thermostat. To reset Wi-Fi, please follow the steps under Wi-Fi Reset on Page 19.
- b. Go to SETTINGS on your Android device and select **Wi-Fi**.
- c. In the list of available networks, select the network named: ICM_I3_XXXXXXXXXX (x's indicate thermostat ID). Your device is connected to the thermostat network when Connected is displayed under the network name.
- d. Open the app and follow the prompts to connect your thermostat to the wireless network.

3. Using a thermostat already listed on your account:



- a. Open the app and sign into your account.
- b. Select the thermostat you wish to connect to the wireless network.
- c. Select **"Settings"** in the top right corner of the app.
- d. In the setting menu, select **"Connect Thermostat to Router"**.
- e. Reset Wi-Fi on thermostat. To reset Wi-Fi, please follow the steps under Wi-Fi Reset on Page 19.
- f. Follow prompts to connect your thermostat to the wireless router.

Using a Computer with Wi-Fi



There are two ways to connect your thermostat to your wireless network using a computer with Wi-Fi: using the WPS button on your wireless router or connecting with your wireless network. If you do not remember your wireless password, you can use the WPS button to connect your thermostat to the network.

1. Reset Wi-Fi on thermostat. To reset Wi-Fi, please follow the steps under Wi-Fi Reset on Page 19.
2. Go to Network Settings in Control Panel and select the network named: ICM_I3_XXXXXXXXXX (x's indicate thermostat ID). You may also connect to the network by clicking on  (Microsoft) or  (Apple) and selecting the correct wireless network.
3. In your internet browser, enter **http://192.168.10.1/** in the address line.

Using Your Wireless Network:

- a. In the list of available networks, select the correct network and enter password (if password protected).
- b.  will stop flashing and  will display, indicating the thermostat is successfully connected to Wi-Fi.

Using the WPS Button:

- a. On your wireless router, press the WPS button until the router indicates it is searching for a wireless device.
 - b. On your computer, scroll to the bottom of the page in the browser and select "Go!" under "Press the WPS button on your Wi-Fi Access Point".
 - c.  will stop flashing and  will display, indicating the thermostat is successfully connected to Wi-Fi.
4. In your internet browser, enter **http://www.captouchwifi.com** in the address line.
 5. Sign into your account.
 6. Under "Add thermostat" enter the thermostat ID, found on a label affixed to the back of the thermostat and on the front of this book.
 7. Enter the thermostat name, zip code, and description.

Testing Wi-Fi Connection

1. In the app or through <http://www.captouchwifi.com>, change fan mode to **ON**.
2. You will hear a click and see  displayed on the thermostat next to fan. Thermostat is successfully connect to the internet.
3. Change the fan mode to the desired setting.

Weather Screen

The thermostat allows you to see the high and low temperature for three days, as well as the current outdoor temperature and relative humidity for the current day – according to the zip code entered at the thermostat registration.



















Press , then press  until **MENU WEATHER** displays.

Press  to advance from one screen to the next.

**** Note:** Pressing  will return you to the previous screen.

To exit weather, press .

Setting the Time and Date

1. Press , then press  until **CLOCK** is displayed.
2. Press  to enter date/time setting. Year blinks.
3. Press  or  to select the year.
4. Press  to save value and move to month.
5. Press  or  to select the month.
6. Press  to save value and move to day.
7. Press  or  to select the day.
8. Press  to save value and move to hour.
9. Press  or  to select the hour.
10. Press  to save the value and move to minutes.
11. Press  or  to select the minutes.
12. Press  to exit Time/Date setting.



**** Note:** As you move past 12:00, the AM/PM symbol will change automatically.

Operating Modes

The possible operating modes for the thermostat are: OFF, HEAT, EM HEAT, COOL, and AUTO. Use  to select.

OFF Mode

• In this mode, the thermostat will not turn on the heating or cooling devices

** **Note:** *The indoor fan can be turned on manually in every operating mode by pressing  until **FAN ON** displays. The fan icon  appears on the display when the fan operates.*

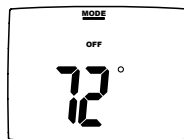

Heat Mode

• In this mode, the thermostat controls the heating system. When the heat outputs, the flame  icon appears on the display for each stage of heat that is on.

** **Note:** *For heat pumps, there is a four minute delay for your compressor to restart after it has turned off. To bypass the compressor time delay, go to OFF mode and press .*

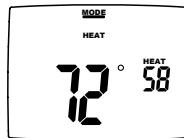

EM Heat Mode

• In this mode, the compressor is bypassed and emergency heat is used.

** **Note:** *This mode is only used with heat pumps.*

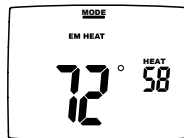

Cool Mode

• In this mode, the thermostat controls the cooling system. When the cooling outputs, the snowflake  icon appears on the display for each stage of cool that is on.

** **Note:** *There is a four minute delay for your compressor to restart after it has turned off. To bypass the compressor time delay, go to OFF mode and press .*

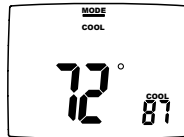

Auto Mode

In this mode, the thermostat controls either heating or cooling systems automatically, depending on displayed room temperature and the heat or cool setpoint.

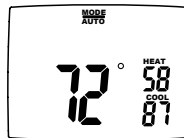



Testing the Thermostat

Once the thermostat is configured, it should be thoroughly tested.



CAUTION!: *Do not energize the air conditioning system when the outdoor temperature is below 50 degrees. It can result in equipment damage or personal injury.*

Heat Test

1. Press , then press  until heat mode is displayed.
2. Adjust the set temperature so it is 5 degrees above the room temperature.
3. Heating should come on within a few seconds.
4. Adjust the set temperature 2 degrees below the room temperature and the heat should turn off. There may be a fan delay on your system.





**** Note:** *For heat pumps, there is a four-minute delay to protect your compressor after it turns off. To bypass the compressor time delay, go to **OFF** mode and press .*

Cool Test

1. Press , then press  until cool mode is displayed.
2. Adjust set temperature so it is 5 degrees below room temperature.
3. Cooling should come on within a few seconds.
4. Adjust the set temperature 2 degrees above the room temperature and the cooling should turn off. There may be a fan delay on your system.

**** Note:** *There is a four-minute time delay to protect the compressor after it turns off. To bypass the compressor time delay, go to **OFF** mode and press .*

Fan Test



1. Press , then press  icon. **FAN ON** displays. Indoor fan turns ON.
2. Press , then press  icon. **FAN AUTO** displays. Indoor fan turns OFF.

Setting the Program Schedule



The thermostat has four periods (WAKE, LEAVE, RETURN, SLEEP) that are customizable for each day of the week. Each period will have a start time, heat temperature, and cool temperature. The thermostat monitors the day and time, while maintaining the specific conditions you have chosen for each period in your program.



**** Note:** You can also set your schedule through the app on your smart device or through <http://www.captouchwifi.com>

Setting the program schedule:

1. Press , then press  until EDIT is displayed.

2. Press  to enter Program Schedule.



3. The day of the week flashes. Use the  or  to select the day of the week.

**** Note:** You can select the days individually, or if you keep pressing  or , there is an option for MON-FRI, MON-SUN or SAT-SUN.



4. Press  to continue.

5. The period (WAKE, LEAVE, RETURN, SLEEP) begins flashing. Use the  or  to select the desired period.

6. Press  to continue.

7. Hour flashes. Use the  or  to select the hour when you want the current period to begin.



8. Press  to continue.

9. The minutes flash. Use the  or  to select the minutes when you want the current period to begin.

10. Press  to continue.

11. The HEAT temperature flashes. Use the  or  to set the desired heat temperature.

12. Press  to continue.



13. The COOL temperature flashes. Use the  or  to set the desired cool temperature.

14. Press  to continue.

Continue to set your entire schedule.

Press  to exit.

View Screen Options



Press , then press  repeatedly until the **MENU** option displays then press .

Press  to advance to the next screen.

Press  to go to previous screen.

**** Note:** *These screens are visible when the thermostat is locked or unlocked.*

View REMOTE SENSOR 1 temperature

  if not used.

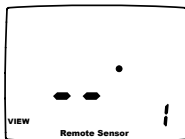

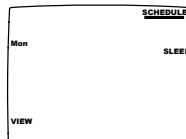

View program schedule settings

- **OFF** shows when schedule is off.
- **SETTINGS** show when schedule is on.



View REMOTE SENSOR 2 temperature

  if not used.

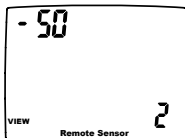

View if locked or unlocked

no = Unlocked
y = Locked

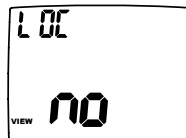

View month, day, and year

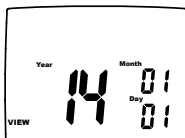

View filter status

Accumulated fan run time displays.

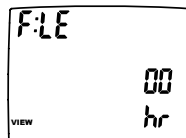

Display setpoints, fan, and program information

Press or to select. = Don't display setpoints and program schedule information.

= Always display setpoints and program schedule information.

REMOTE SENSOR 1 = REMOTE SENSOR 1 temperature will display.

REMOTE SENSOR 2 = REMOTE SENSOR 2 temperature will display.

Press to exit.

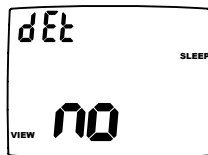

Schedule Override

The schedule override feature allows the user to override the program schedule for 1 to 5 hours. In addition, if selected, the schedule can be overridden only until the next transition period.

To access the Schedule override feature, enter the screen, then use to scroll through the menu options until you reach the SCHEDULE OVERRIDE screen. In the default setting, the Vacation & Schedule periods will be flashing in the upper right corner of the LCD. In this mode, the Vacation & Schedule will be overridden until the next transition period. To switch to the 1-5 hour override, use the arrow. This mode allows the user to override the Schedule set points for 1-5 hours.

Setting the Vacation Timer

The vacation timer lets you set the date and time of your RETURN from vacation. Until that date/time, the system will remain at the VACATION heating and cooling setpoints specified in the configuration menu.

To use the EASY VACATION feature:

Press , then press the to scroll to "Vacation" then press again. The thermostat will automatically go into Vacation mode with the default return date 1 month later .

To set the vacation timer (and begin vacation setpoint mode):

1. Press to select operating mode.
2. Press , then press until VACATION appears.
3. Press to enter the date and time you plan to RETURN from vacation.
4. When your finished entering the date/time, press .

Factory Preprogramming

The thermostat comes pre-programmed with the following schedule:

MONDAY
thru
SUNDAY

WAKE	6:00 AM
HEAT	70°F
COOL	78°F

LEAVE	8:00 AM
HEAT	62°F
COOL	85°F

RETURN	6:00 PM
HEAT	70°F
COOL	78°F

SLEEP	10:00 PM
HEAT	62°F
COOL	82°F

Use the following personal program schedule to record your settings:

MONDAY
1

WAKE	
HEAT	
COOL	

LEAVE	
HEAT	
COOL	

RETURN	
HEAT	
COOL	

SLEEP	
HEAT	
COOL	

TUESDAY
2

WAKE	
HEAT	
COOL	

LEAVE	
HEAT	
COOL	

RETURN	
HEAT	
COOL	

SLEEP	
HEAT	
COOL	

WEDNESDAY
3

WAKE	
HEAT	
COOL	

LEAVE	
HEAT	
COOL	

RETURN	
HEAT	
COOL	

SLEEP	
HEAT	
COOL	

THURSDAY
4

WAKE	
HEAT	
COOL	

LEAVE	
HEAT	
COOL	

RETURN	
HEAT	
COOL	

SLEEP	
HEAT	
COOL	

Personal Program Schedule (continued)

FRIDAY
5

WAKE	
HEAT	
COOL	

LEAVE	
HEAT	
COOL	

RETURN	
HEAT	
COOL	

SLEEP	
HEAT	
COOL	

SATURDAY
6

WAKE	
HEAT	
COOL	

LEAVE	
HEAT	
COOL	

RETURN	
HEAT	
COOL	

SLEEP	
HEAT	
COOL	

SUNDAY
7











WAKE	
HEAT	
COOL	

LEAVE	
HEAT	
COOL	







RETURN	
HEAT	
COOL	

SLEEP	
HEAT	
COOL	

Troubleshooting

Symptom	Remedy
No display	Check for 24 VAC at thermostat; display is blank when 24 VAC is not present.
System fan does not come on properly	Verify wiring is correct, check heat source (Gas/Electric) in Configuration (see Section 7, Page 14).
No response with first button press	Press  to activate touch icons.
Program schedule activates at wrong time	Check time (AM/PM) set on thermostat (see Setting the Time & Date, Page 22).
Thermostat turns on/off too frequently	Adjust temperature differential (see Configuration Mode Setting, Pages 12-13).
Thermostat does not follow program	Verify the schedule is on  : check time (AM/PM); check if in program override.
Fan runs continuously	Press  and set to auto  is continuous run.
Room temperature is not correct	Calibrate thermostat (see Configuration Mode Setting, Section 17, Page 17). If remote sensor is used, check S1 and S2 terminal connections.
LOCK displays when any button is pressed	Thermostat has the button lockout function activated (see Lockout & Unlock Feature, Page 11).
 on display instead of room temperature	Check for a bad connection at S1 and S2 terminals, if used (see Configuration Mode Setting, Section 19, Pages 18).
Heat or Cool not coming on	Verify wiring is correct, gently pull on each wire to verify there is a good connection at terminal block.
Remote Sensor displays	Check remote sensors temperature at  ,  ,  ,  .
OVERRIDE displays	Program schedule is in temporary override, it will return to schedule at next transition time.
Thermostat ID location	The thermostat ID is attached to the front of this book, as well as on the back of the thermostat above the terminals.
 not displayed on thermostat	Reconnect thermostat as if for the first time.
No outputs activate upon power-up	Upon Power-up the thermostat will not activate outputs for four minutes. To bypass the output lockout, change the setpoint temperature in heat or cool mode on the thermostat, by the temperature differential.

Troubleshooting (continued)

Symptom	Remedy
Setpoints do not display all of the time	  Press  MENU VIEW ,  six times,
Problems connecting using the app	Connect your thermostat using a computer with Wi-Fi. If you are having trouble, the best option is to use the WPS button (as described under Using a Computer with Wi-Fi, Page 21).
Problem finding app	Apple devices require iOS 7.0 or newer software. Android devices require Android Honeycomb (Android version 3.1) or newer software.
Offline 	If the thermostat or APP shows offline () for more than a few minutes, unplug the thermostat from the wall plate, wait one minute, then plug thermostat back into wall plate.

FCC Compliance Statement (Part 15.19)

This device complies with part 15 of the FCC Rules. Operation is subject to the following two conditions: (1) This device may not cause harmful interference, and (2) this device must accept any interference received, including interference that may cause undesired operation.

FCC Part 15.21 Statement

Modifications or changes made to the device, not approved by the originating party, may void user authority to operate the device.

FCC RF Exposure Statement

To ensure FCC and Industry Canada compliance, maintain a separation distance of 20 cm from device.

Section 7.1.2 of RSS-GEN

Under Industry Canada regulations, this radio transmitter may only operate using an antenna of a type and maximum (or lesser) gain approved for the transmitter by Industry Canada. To reduce potential radio interference to other users, the antenna type and its gain should be so chosen that the equivalent isotropically radiated power (e.i.r.p.) is not more than that necessary for successful communication.

Conformément à la réglementation d'Industrie Canada, le présent émetteur radio peut fonctionner avec une antenne d'un type et d'un gain maximal (ou inférieur) approuvé pour l'émetteur par Industrie Canada. Dans le but de réduire les risques de brouillage radioélectrique à l'intention des autres utilisateurs, il faut choisir le type d'antenne et son gain de sorte que la puissance isotrope rayonnée équivalente (p.i.r.e.) ne dépasse pas l'intensité nécessaire à l'établissement d'une communication satisfaisante.

Section 7.1.3 of RSS-GEN

This device complies with Industry Canada license-exempt RSS standard(s). Operation is subject to the following two conditions: (1) this device may not cause interference, and (2) this device must accept any interference, including interference that may cause undesired operation of the device.

Le présent appareil est conforme aux CNR d'Industrie Canada applicables aux appareils radio exempts de licence. L'exploitation est autorisée aux deux conditions suivantes : (1) l'appareil ne doit pas produire de brouillage, et (2) l'appareil doit accepter tout brouillage radioélectrique subi, même si le brouillage est susceptible d'en compromettre le fonctionnement.

FIVE-YEAR LIMITED WARRANTY

The Seller warrants its products against defects in material or workmanship for a period of five (5) years from the date of manufacture. The liability of the Seller is limited, at its option, to repair, replace or issue a non-case credit for the purchase prices of the goods which are provided to be defective. The warranty and remedies set forth herein do not apply to any goods or parts thereof which have been subjected to misuse including any use or application in violation of the Seller's instructions, neglect, tampering, improper storage, incorrect installation or servicing not performed by the Seller.

In order to permit the Seller to properly administer the warranty, the Buyer shall: 1) Notify the Seller promptly of any claim, submitting date code information or any other pertinent data as requested by the Seller. 2) Permit the Seller to inspect and test the product claimed to be defective. Items claimed to be defective and are determined by Seller to be non-defective are subject to a \$30.00 per hour inspection fee. This warranty constitutes the Seller's sole liability hereunder and is in lieu of any other warranty expressed, implied or statutory. Unless otherwise stated in writing, Seller makes no warranty that the goods depicted or described herein are fit for any particular purpose.

*Scan now to download
the i3 app now!*



For Apple phones



For Android phones

1. Download the app.
2. Follow steps on Pages 19-22.
3. Control your **EL**[™] thermostat from anywhere using your cell phone.



Patent 6,597,275 – Thermal Intrusion Barrier
Patent Pending 14,307,650 – DC Thermostat with Latching Relay Repulsing

2713 William Barry Blvd., North Syracuse, NY 13212
(Toll Free) 800-365-5525 (Phone) 315-233-5266 (Fax) 315-233-5276

www.icmcontrols.com