



SC2201

Non-Programmable Electronic Thermostats



- For use with Heat Pumps
- Up to 2-Stage Heat, 1-Stage Cool
- 30-Minute Power Loss Memory Retention
- For use with 24 VAC Systems
- Optional backlit display (SC2201L only)

Installation, Operation & Application Guide

For more information on our complete range of American-made products – plus wiring diagrams, troubleshooting tips and more, visit us at www.icmcontrols.com



Table of Contents

| | | | |
|--------------------------------------|---|--|----|
| Parts Diagram | 1 | Wiring Diagrams | 10 |
| Specifications | 2 | <i>Carrier Split Stream Condensers</i> | 10 |
| Features/Benefits..... | 2 | <i>Coleman 3000 Series</i> | 11 |
| Package Contents/Tools Required..... | 2 | <i>Comfortmaker CYC Series</i> | 12 |
| Important Safety Information | 3 | <i>Heil-Quaker 867.814 Series and PH50 Series</i> | 13 |
| General Description..... | 3 | <i>Payne Reliant and Endura Model</i> | 14 |
| To Remove Existing Thermostat | 4 | <i>Rheem/Ruud:</i> | |
| Replacing Wiring Labels | 4 | <i>-PGB, -PFA, -PCB, -PLA, and -PKA Series</i> | 15 |
| To Install Thermostat | 5 | <i>Goodman, Janitrol, Trane/American Standard</i> | 16 |
| Testing the Thermostat | 6 | <i>York -E1CS, -E1FB, E1FH</i> | 17 |
| LED Indicators..... | 8 | <i>Lennox CB19</i> | 18 |
| Operation | 8 | <i>Lennox HP19 and HP20</i> | 19 |
| | | <i>FHP 1 Stage</i> | 20 |
| | | Troubleshooting | 21 |

CAUTION!: *This thermostat should be installed by trained technicians only. Adhere to all local and national codes. Disconnect all power to the system before installing, removing, or cleaning.*

Parts Diagram

SC2201

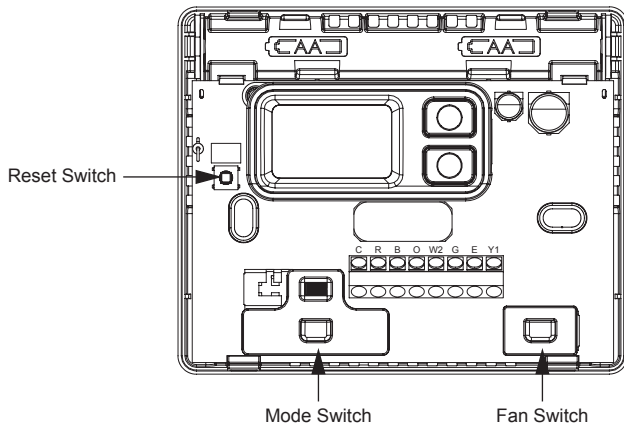

Specifications

Input:

- **Voltage:** 24 VAC (18-30 VAC)

Output:

- **Maximum:** 1 amp maximum load per terminal
(4 amp total maximum load for all terminals)
- **Temperature Ranges:**
 - **Temperature control range:** 45°F to 90°F **Accuracy:** $\pm 1^\circ\text{F}$
 - **Differential range:** 1°F to 3°F
- **System configurations:** Multi-stage heat pump (two-stage heat, one-stage cool)
- **Terminations:** R, C, E, Y1, O, B, G, W2
- **Second stage activation in heat mode:** 2° below first stage (not adjustable)

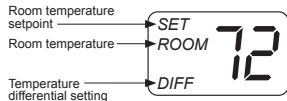

Features/Benefits

- Multi-stage heating/cooling control
- Multi-colored LED indicators for system status
- Zone system compatible as a master thermostat
- Adjustable temperature differential: 1°F to 3°F
- Automatic heating system shutdown if temperature exceeds 90°F
- 30-minute power interruption memory retention
- Independent setpoints for heat and cool

Package Contents/Tools Required

Package includes: SimpleComfort® 2201 non-programmable thermostat on base, thermostat cover, wiring labels, screws and wall anchors, Installation, Operation and Application Guide.

Tools required for installation: Drill with 3/16" bit, hammer, screwdriver.

Important Safety Information

- Always turn off power at the main power source by unscrewing fuse or switching circuit breaker to the off position before installing, removing, cleaning, or servicing this thermostat
- Read all of the information in this manual before installing this thermostat
- This thermostat should be installed only by a professional contractor
- This is a 24 VAC low-voltage thermostat; do not install on voltages higher than 30 VAC
- All wiring must conform to local and national building and electrical codes and ordinances
- Do not switch system to cool if the outdoor temperature is below 50°F; this can damage the air conditioning system and may cause personal injury
- The thermostat will not control your heating/air conditioning system without power; it requires a continuous 24 VAC circuit for proper system control
- Use this thermostat only as described in this manual
- While cleaning, do not get soap directly on thermostat switches or LCD readout; only use a damp cloth with a mild soap to wipe outside of thermostat cover

General Description

The SimpleComfort[®] 2201 is intended to operate and is compatible with 24 VAC residential heat pumps with up to 2-stage heat/1-stage cool. It will operate with heat pump systems that are manual changeover and have auxiliary or emergency heating. There are no optional items required for standard installations. This thermostat is also compatible as a master thermostat in zoned system applications.

To Remove Existing Thermostat



ELECTRICAL SHOCK HAZARD – Turn off power at the main service panel by removing the fuse or switching the appropriate circuit breaker to the Off position before removing the existing thermostat.

1. Turn off power to the heating and cooling system by removing the fuse or switching off the appropriate circuit breaker.
2. Remove cover of old thermostat. This should expose the wires.
3. **Label the existing wires with the enclosed wire labels before removing wires.** See table below for old and new label identification.
4. After labeling wires, remove wires from wire terminals.
5. Remove existing thermostat base from wall.
6. Refer to the following section for instructions on how to install this thermostat.

Replacing Wiring Labels

Replace the old labels with the enclosed new labels:

| Old | New | Type |
|-----------------|-----|----------------------------------|
| R, V-VR or VR-R | R | 24 VAC, return |
| Y, Y1 or M | Y1 | Stage 1 cooling/heating circuit |
| O or R | O | Reversing valve (cooling active) |
| B | B | Reversing valve (heat active) |
| G or F | G | Fan contactor circuit |
| W1, W2 or W-U | W2 | 2nd stage heating circuit |
| E | E | Emergency heating circuit |
| C, X or B | C | 24 VAC, transformer common side |

To Install Thermostat



ELECTRICAL SHOCK HAZARD – Turn off power at the main service panel by removing the fuse or switching the appropriate circuit breaker to the Off position before removing the existing thermostat.

IMPORTANT: Thermostat installation must conform to local and national building and electrical codes and ordinances.

IMPORTANT: This thermostat is compatible with 100% lockout systems. To reset the system, turn thermostat to Off position for at least 60 seconds.

**** Note:** Mount the thermostat about five feet above the floor. Do not mount the thermostat on an outside wall, in direct sunlight, behind a door, or in an area affected by a vent or duct.

1. Turn off power to the heating and cooling system by removing the fuse or switching off the appropriate circuit breaker.
2. Put **Mode** switch in **Off** position.
3. Put **Fan** switch in **Auto** position.
4. To remove cover, insert and twist a coin or screwdriver in the slot on the top of the thermostat.
5. Put thermostat base against the wall where you plan to mount it (Be sure wires will feed through the wire opening in the base of the thermostat).
6. Mark the placement of the mounting holes.
7. Set thermostat base and cover away from working area.
8. Using a 3/16" drill bit, drill holes in the places you have marked for mounting.
9. Use a hammer to tap supplied anchors in mounting holes.
10. Align thermostat base with mounting holes and feed the control wires through wire opening.
11. Use supplied screws to mount thermostat base to wall.
12. Insert stripped, labeled wires in matching wire terminals. See Wiring Diagrams section of this manual (Pages 10-20).

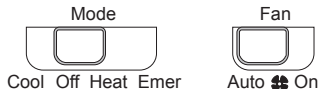

CAUTION! Be sure exposed portion of wires does not touch other wires.

13. Tighten screws on terminal block. Gently tug wire to be sure of proper connection. Double check that each wire is connected to the proper terminal.
14. Replace cover on thermostat by snapping it in place.
15. Turn on power to the system at the main service panel.
16. Test thermostat operation as described in the following section.

Testing the Thermostat

CAUTION!: Do not switch system to cool if the outdoor temperature is below 50°F. This can damage the air conditioning system and may cause personal injury.

1. Put the **Mode** switch to **Cool** position.
 2. Press the \vee button until the temperature setting is at least 3 degrees below the room temperature. The air conditioning system and fan should turn on.
 3. Put the **Mode** switch in the **Off** position. The air conditioning system should turn off. The fan may have a delay.
- ** **Note:** Pressing the **Reset** button once will bypass the 5-minute anti-short cycle compressor protection.

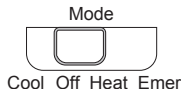
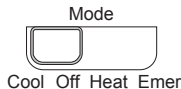

**** Note:** While in Cool or Heat mode, once the thermostat turns the system off, a built-in delay keeps the compressor from turning on for about 5 minutes. This protects the compressor.

4. Put the **Mode** switch to the **Heat** position.

5. Press the \wedge button until the temperature setting is at least 3 degrees above room temperature. The heating system should turn on.

**** Note:** The compressor may not turn on again for 5 minutes.

6. Put the **Mode** switch to the **Off** position. The heating system should turn off. Once again the fan may have a delay.

7. Put the **Fan** switch to the **On** position. The blower fan should turn on.

8. Put the **Fan** switch to the **Auto** position. The blower fan should turn off.

If all functions operate properly, the thermostat is installed correctly.

If the thermostat does not operate properly:

- Check all wiring connections
- See Troubleshooting (Page 21)

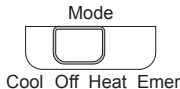
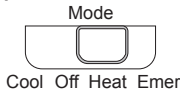

LED Indicators

There are two LED indicators located on the front of the thermostat. They are designed to inform you of the following:

AUX (GREEN): This turns on when the auxiliary (back-up) heating is in operation. This is the second (non-economy) stage of heat. It turns on 2 degrees below first stage and is not adjustable.

EMER (RED): This light turns on whenever the emergency heat is manually selected (system switch is in the EMER position). While in the emergency heat mode, the heat pump compressor is off, and the emergency heat (same as the auxiliary heat) maintains the setpoint temperature.



Operation

Setting the Room Temperature (Setpoint Temperature)

Step 1: Press the \vee or \wedge button; the current temperature setpoint displays.

Step 2: Press the \vee or \wedge button until the desired temperature setpoint displays.

* **Note:** Holding down either the \vee or \wedge button will scroll the temperature display.

The new temperature setting is automatically saved. After 5 seconds, the display returns to showing the current room temperature.



Setting a New Temperature Differential

IMPORTANT: The default temperature differential is factory set at 1°F. When your room temperature varies by 1°F, the thermostat turns your system on. If you notice your system turning on and off too frequently, increase the temperature differential accordingly.

Step 1: Remove cover. Insert a coin or screwdriver in slot at top if needed.

Step 1: Press the reset button once (see diagram on Page 1).

Step 3: The display will show _____
This is the temperature differential setting.



Step 4: Press the \vee or \wedge button to adjust the temperature differential down or up.

Step 5: Replace the thermostat cover.

The display will return to the room temperature display five seconds after the last input. The new temperature differential setting will be saved.

| Differential Setting | °F |
|----------------------|-----|
| 1 | 1°F |
| 2 | 2°F |
| 3 | 3°F |

Starting the Thermostat

Step 1: Move the **Fan** switch into the **Auto** position.

- In Auto, indoor fan runs only during a heating or cooling cycle
- In ON, indoor fan runs continuously



Step 2: Move the **Mode** switch to either **Cool** or **Heat** position, depending on the season. The thermostat will now operate and maintain the room temperature at the desired setpoint.

- ** Note:** When the thermostat operates the system, there is built-in compressor protection. After the compressor turns off, the system will not turn it back on for about five minutes. This protects the compressor.

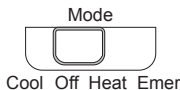

Wiring Diagrams

SimpleComfort® 2201 Electronic Thermostat Conversion to: *Carrier Split Stream Condensers and Heat Pump Systems*

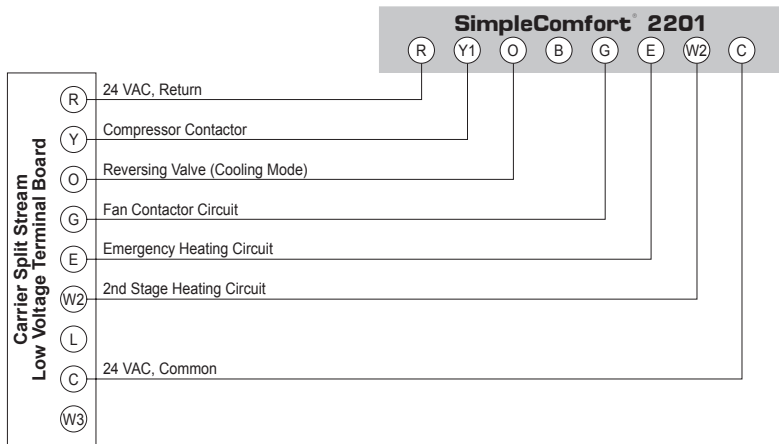

SimpleComfort® 2201 Electronic Thermostat Conversion to: *Coleman 3000 Series Heat Pump Systems*

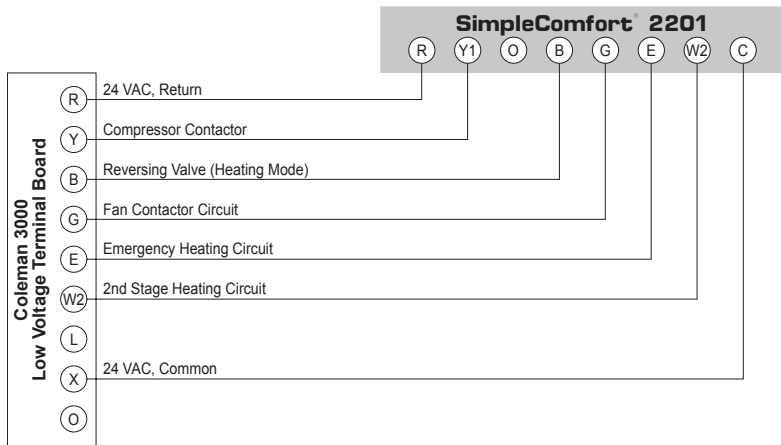

SimpleComfort® 2201 Electronic Thermostat Conversion to: *Comfortmaker CYC Series Heat Pump Systems*

Note 1: E and W2 terminals jumpered at thermostat.
Note 2: W2 terminal on Comfortmaker capped at PCB.
Note 2: X terminal on Comfortmaker capped at PCB.

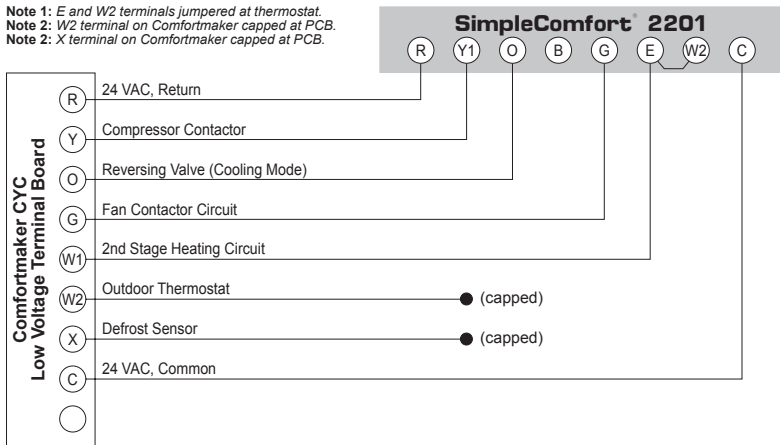

SimpleComfort® 2201 Electronic Thermostat Conversion to: Heil-Quaker 867.814 Series and PH50 Series Heat Pump Systems

Note 1: E and W2 terminals jumpered at thermostat.

Note 2: W2 terminal on Heil-Quaker capped at PCB.

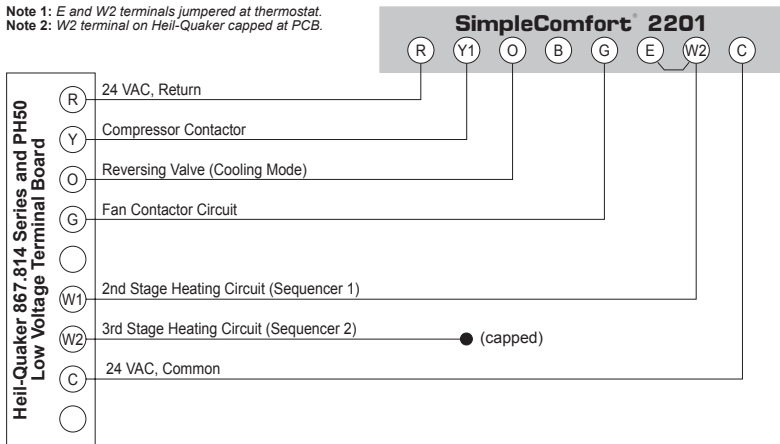

SimpleComfort® 2201 Electronic Thermostat Conversion to: Payne Reliant and Endura Model Heat Pump Systems

Note 1: W3 terminal on Payne PCB capped at PCB.

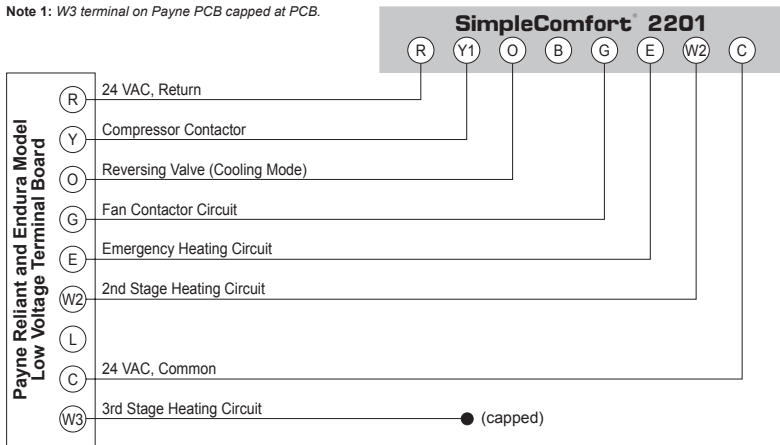

SimpleComfort® 2201 Electronic Thermostat Conversion to: Rheem/Ruud: -PGB, -PFA, -PCB, -PLA, and -PKA Series Heat Pump Systems

Note 1: E and W2 terminals jumpered at thermostat.

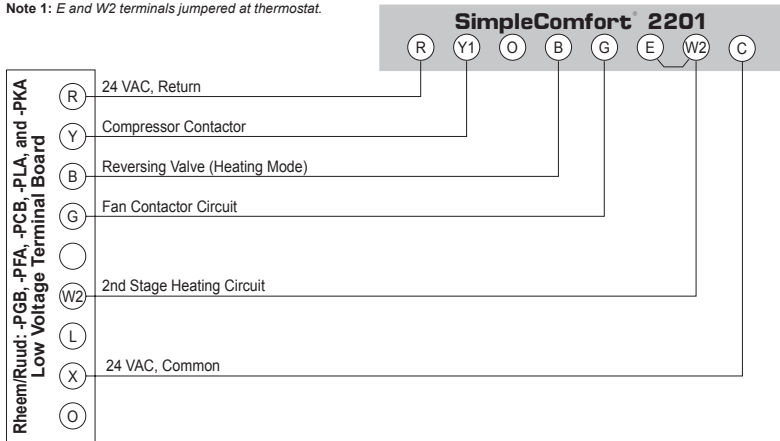

SimpleComfort® 2201 Electronic Thermostat Conversion to: Goodman, Janitrol, Trane/American Standard Heat Pump Systems

Note 1: E and W2 terminals jumpered at thermostat.

Note 2: X2 terminal on Goodman, etc. capped at PCB.

Note 3: T terminal on Goodman, etc. capped at PCB.

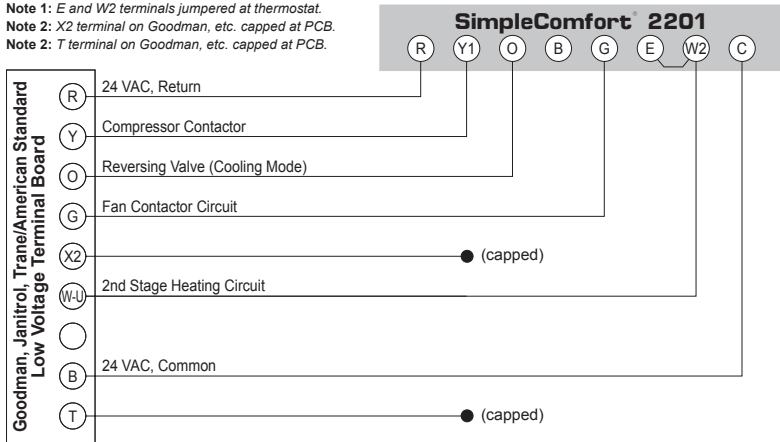

SimpleComfort® 2201 Electronic Thermostat Conversion to: York -E1CS, -E1FB, E1FH Heat Pump Systems

Note 1: E and W2 terminals jumpered at thermostat.

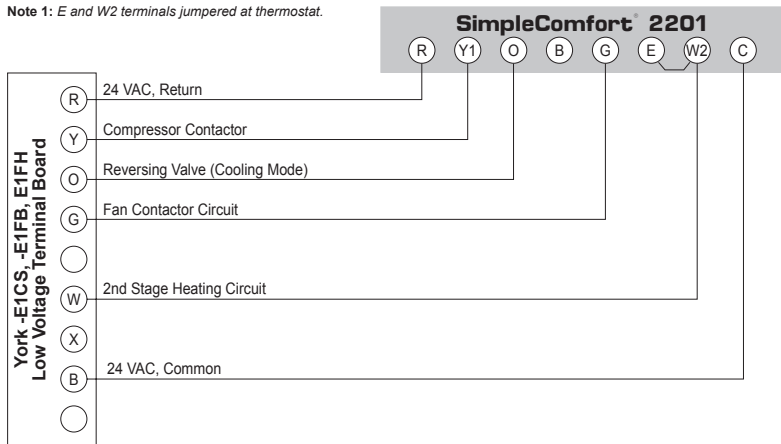

SimpleComfort® 2201 Electronic Thermostat Conversion to: *Lennox CB19 Heat Pump Systems*

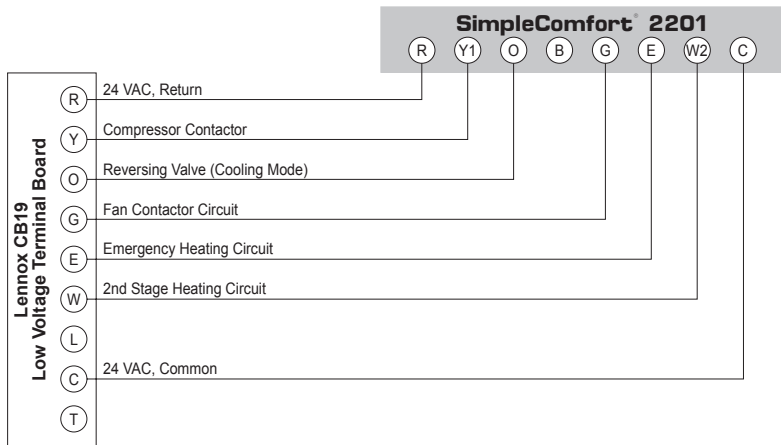

SimpleComfort® 2201 Electronic Thermostat Conversion to: *Lennox HP19 and HP20 Heat Pump Systems*

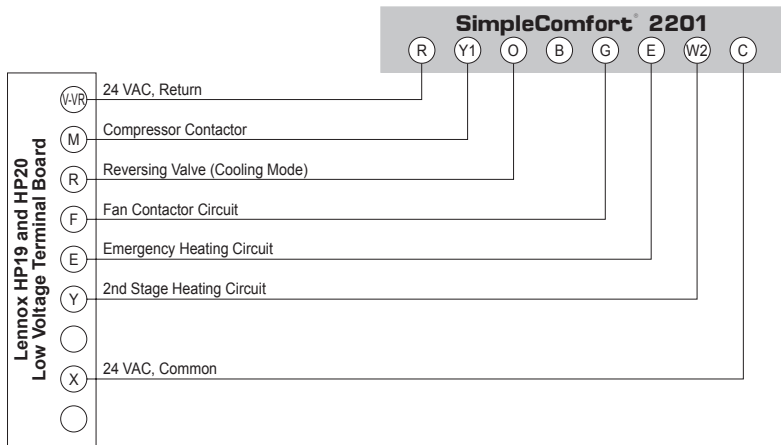

SimpleComfort® 2201 Electronic Thermostat Conversion to: *FHP 1 Stage Heat Pump Systems*

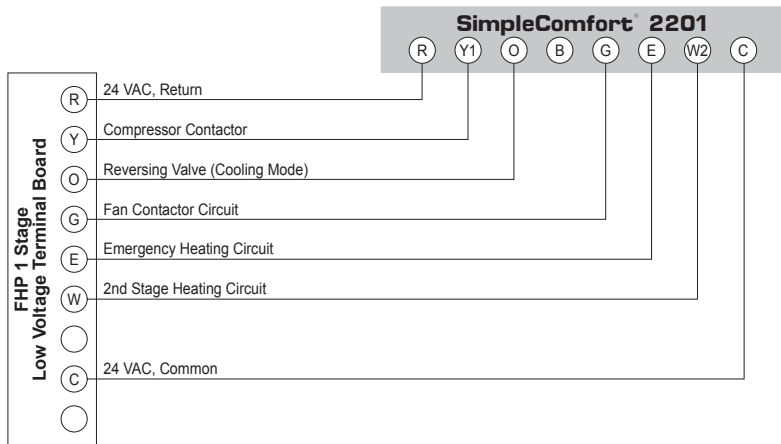

Note: For units with ECM motors and the 641-065 interface board, connect W2 from the thermostat to W1 at the heat pump.

Troubleshooting

| Symptom | Remedy |
|---|---|
| The system is not turning on | Check the wiring (see Installation, Page 5) |
| LCD is blank or displaying "Lo Bat" | Verify 24 VAC is at thermostat |
| Thermostat does not turn on the system as frequently as it should | Decrease the temperature differential (see Setting a New Temperature Differential, Page 9) |
| Thermostat is not properly controlling the fan | Check the wiring (see Installation, Page 5) |
| Thermostat is continuously turning on and off | Increase the temperature differential (see Setting a New Temperature Differential, Page 9) |
| Temperature display is not accurate | Verify no heat producing objects are located near the thermostat Verify thermostat has adequate air flow to it |
| Display not correct | Press the reset button once – display will be refreshed |

ONE-YEAR LIMITED WARRANTY

The Seller warrants its products against defects in material or workmanship for a period of one (1) year from the date of manufacture. The liability of the Seller is limited, at its option, to repair, replace or issue a non-case credit for the purchase prices of the goods which are provided to be defective. The warranty and remedies set forth herein do not apply to any goods or parts thereof which have been subjected to misuse including any use or application in violation of the Seller's instructions, neglect, tampering, improper storage, incorrect installation or servicing not performed by the Seller. In order to permit the Seller to properly administer the warranty, the Buyer shall: 1) Notify the Seller promptly of any claim, submitting date code information or any other pertinent data as requested by the Seller. 2) Permit the Seller to inspect and test the product claimed to be defective. Items claimed to be defective and are determined by Seller to be non-defective are subject to a \$30.00 per hour inspection fee. This warranty constitutes the Seller's sole liability hereunder and is in lieu of any other warranty expressed, implied or statutory. Unless otherwise stated in writing, Seller makes no warranty that the goods depicted or described herein are fit for any particular purpose.



Patent No. 424,953

7313 William Barry Blvd., North Syracuse, NY 13212
(Toll Free) 800-365-5525 (Phone) 315-233-5266 (Fax) 315-233-5276

www.icmcontrols.com

LIA277